

**RAF-25NH4/RAC-25NH4
RAF-50NH4/RAC-50NH4**

SERVICE MANUAL TECHNICAL INFORMATION

REFER TO THE FOUNDATION MANUAL

FOR SERVICE PERSONNEL ONLY

CONTENTS

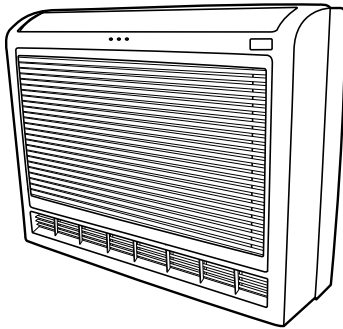

RAF-25NH4
RAF-50NH4

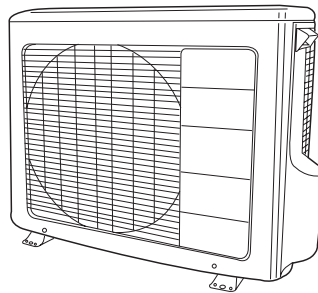

RAC-25NH4
RAC-50NH4

SPECIFICATIONS 5
 HOW TO USE 9
 CONSTRUCTION AND DIMENSIONAL DIAGRAM 30
 MAIN PARTS COMPONENT 32
 WIRING DIAGRAM 35
 CIRCUIT DIAGRAM 41
 BLOCK DIAGRAM 45
 BASIC MODE 47
 REFRIGERATING CYCLE DIAGRAM 59
 DESCRIPTION OF MAIN CIRCUIT OPERATION 64
 SERVICE CALL Q & A 72
 DISASSEMBLY AND REASSEMBLY 76
 TROUBLE SHOOTING 82
 PARTS LIST AND DIAGRAM 102

SPECIFICATIONS

TYPE		DC INVERTER (CONSOLE)			
		INDOOR UNIT	OUTDOOR UNIT	INDOOR UNIT	OUTDOOR UNIT
MODEL		RAF-25NH4	RAC-25NH4	RAF-50NH4	RAC-50NH4
POWER SOURCE		1 PHASE, 50 Hz, 230V		1 PHASE, 50 Hz, 230V	
COOLING	TOTAL INPUT (W)	695 (155~1,050)		1,780 (155~2,200)	
	TOTAL AMPERES (A)	3.05		7.82	
	CAPACITY	(kW)	2.50 (0.90 ~ 3.00)		5.00 (0.90 ~ 5.20)
(B.T.U./h)		8,540		17,070	
HEATING	TOTAL INPUT (W)	1,000 (115 ~ 1,400)		1,970 (115 ~ 2,100)	
	TOTAL AMPERES (A)	4.4		8.65	
	CAPACITY	(kW)	3.90 (0.90 ~ 5.00)		6.70 (0.90 ~ 8.10)
(B.T.U./h)		13,300		22,200	
DIMENSIONS (mm)	W	750	750	750	850
	H	600	570	600	650
	D	215	280	215	298
NET WEIGHT (kg)		15	38	15	60

SPECIFICATIONS AND PARTS ARE SUBJECT TO CHANGE FOR IMPROVEMENT



M AIR CONDITIONER

Большая библиотека технической документации

<https://splitsystema48.ru/instrukcii-po-ekspluatatsii-kondicionerov.html>

каталоги, инструкции, сервисные мануалы, схемы.

SAFETY DURING REPAIR WORK

1. In order to disassemble and repair the unit in question, be sure to disconnect the power cord plug from the power outlet before starting the work.

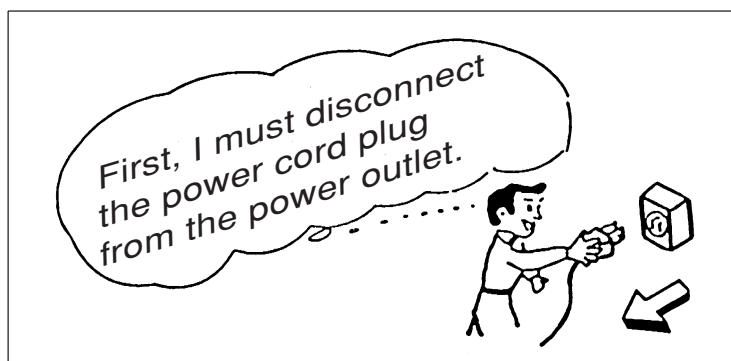

2. If it is necessary to replace any parts, they should be replaced with respective genuine parts for the unit, and the replacement must be effected in correct manner according to the instructions in the Service Manual of the unit.

If the contacts of electrical parts are defective, replace the electrical parts without trying to repair them.



3. After completion of repairs, the initial state should be restored.
4. Lead wires should be connected and laid as in the initial state.
5. Modification of the unit by user himself should absolutely be prohibited.
6. Tools and measuring instruments for use in repairs or inspection should be accurately calibrated in advance.
7. In installing the unit having been repaired, be careful to prevent the occurrence of any accident such as electrical shock, leak of current, or bodily injury due to the drop of any part.
8. To check the insulation of the unit, measure the insulation resistance between the power cord plug and grounding terminal of the unit. The insulation resistance should be $1M\Omega$ or more as measured by a 500V DC megger.
9. The initial location of installation such as window, floor or the other should be checked for being and safe enough to support the repaired unit again. If it is found not so strong and safe, the unit should be installed at the initial location reinforced or at a new location.
10. Any inflammable thing should never be placed about the location of installation.
11. Check the grounding to see whether it is proper or not, and if it is found improper, connect the grounding terminal to the earth.



WORKING STANDARDS FOR PREVENTING BREAKAGE OF SEMICONDUCTORS

1. Scope

The standards provide for items to be generally observed in carrying and handling semiconductors in relative manufacturers during maintenance and handling thereof. (They apply the same to handling of abnormal goods such as rejected goods being returned).

2. Object parts

- (1) Micro computer
- (2) Integrated circuits (IC)
- (3) Field-effect transistors (FET)
- (4) P.C. boards or the like on which the parts mentioned in (1) and (2) of this paragraph are equipped.

3. Items to be observed in handling

- (1) Use a conductive container for carrying and storing of parts. (Even rejected goods should be handled in the same way).

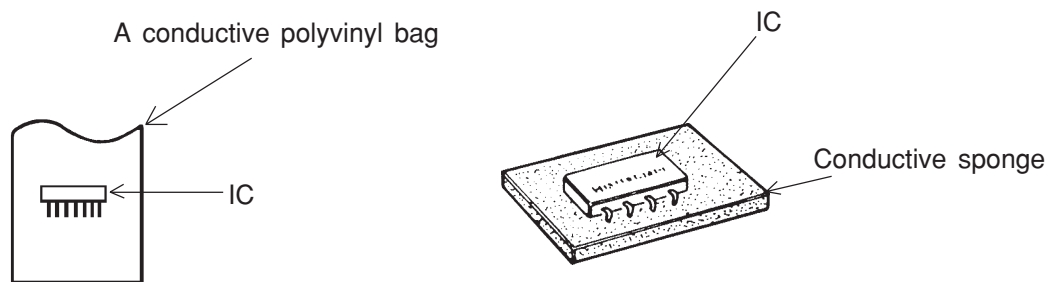

Fig. 1. Conductive Container

- (2) When any part is handled uncovered (in counting, packing and the like), the handling person must always use himself as a body earth. (Make yourself a body earth by passing one M ohm earth resistance through a ring or bracelet).
- (3) Be careful not to touch the parts with your clothing when you hold a part even if a body earth is being taken.
- (4) Be sure to place a part on a metal plate with grounding.
- (5) Be careful not to fail to turn off power when you repair the printed circuit board. At the same time, try to repair the printed circuit board on a grounded metal plate.

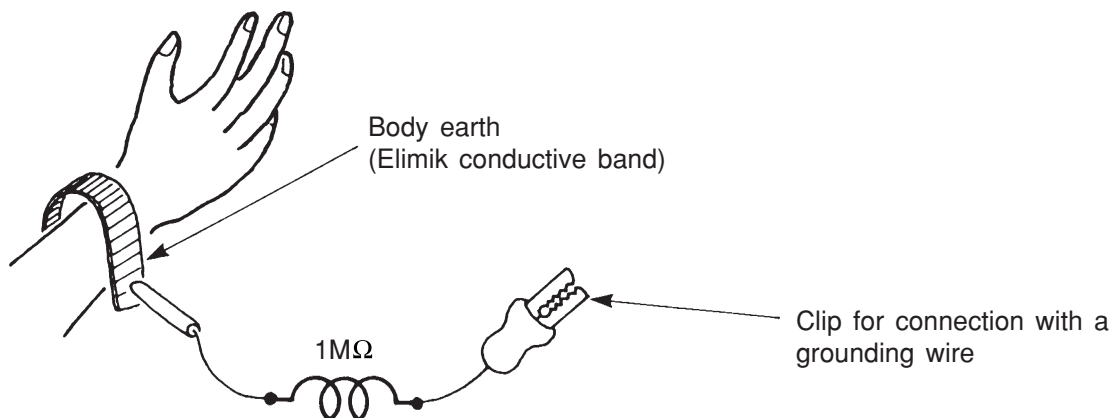

Fig. 2. Body Earth

(6) Use a three wire type soldering iron including a grounding wire.

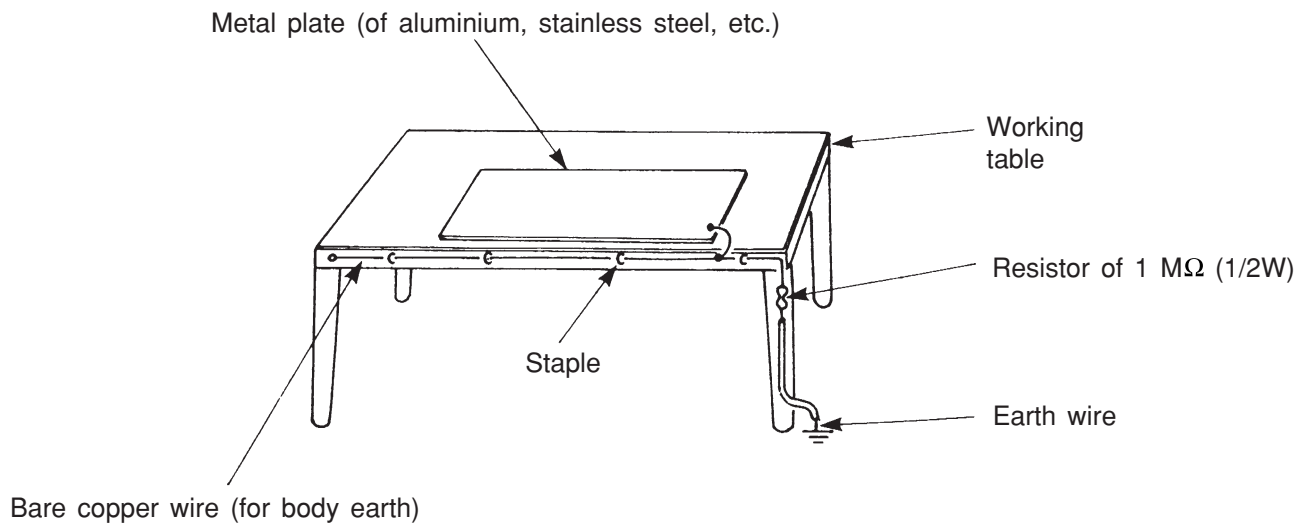

Fig. 3. Grounding of the working table

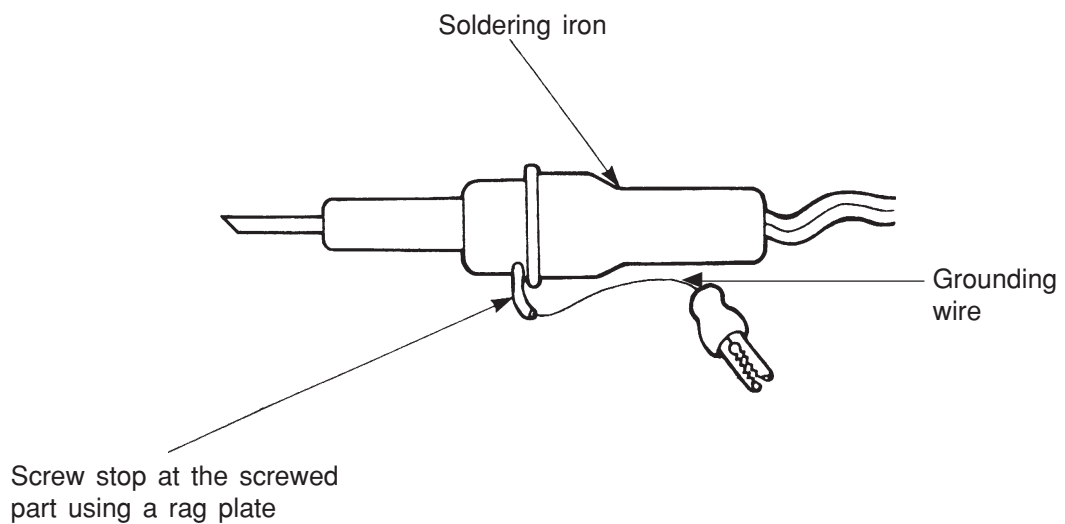

Fig. 4. Grounding a soldering iron

Use a high insulation mode (100V, 10MΩ or higher) when ordinary iron is to be used.

(7) In checking circuits for maintenance, inspection or some others, be careful not to have the test probes of the measuring instrument shortcircuit a load circuit or the like.

 **CAUTION**

1. In quiet or stopping operation, slight flowing noise of refrigerant in the refrigerating cycle is heard occasionally, but this noise is not abnormal for the operation.
2. When it thunders near by, it is recommend to stop the operation and to disconnect the power cord plug from the power outlet for safety.
3. In the event of power failure, the air conditioner will restart automatically in the previously selected mode once the power is restored. In the event of power failure during TIMER operation, the timer will be reset and the unit will begin or stop operating under a new timer setting.
4. If the room air conditioner is stopped by adjusting thermostat, or missoperation, and re-start in a moment, there is occasion that the cooling and heating operation does not start for 3 minutes, it is not abnormal and this is the result of the operation of IC delay circuit. This IC delay circuit ensures that there is no danger of blowing fuse or damaging parts even if operation is restarted accidentally.
5. This room air conditioner should not be used at the cooling operation when the outside temperature is below 10°C (50°F).
6. This room air conditioner (the reverse cycle) should not be used when the outside temperature is below -15°C (5°F).
If the reverse cycle is used under this condition, the outside heat exchanger is frosted and efficiency falls.
7. When the outside heat exchanger is frosted, the frost is melted by operating the hot gas system, it is not trouble that at this time fan stops and the vapour may rise from the outside heat exchanger.

SPECIFICATIONS

MODEL		RAF-25NH4 RAF-50NH4	RAC-25NH4	RAC-50NH4
FAN MOTOR		20W(DC35V)	40W	
FAN MOTOR CAPACITOR		NO	NO	
FAN MOTOR PROTECTOR		NO	NO	
COMPRESSOR		NO	JU1012D	JU1013D
COMPRESSOR MOTOR CAPACITOR		NO	NO	
OVERLOAD PROTECTOR		NO	YES	
OVERHEAT PROTECTOR		NO	YES	
FUSE (for MICROPROCESSOR)		NO	3.0A	
POWER RELAY		NO	G4A	
POWER SWITCH		NO	NO	
TEMPORARY SWITCH		YES	NO	
SERVICE SWITCH		NO	YES	
TRANSFORMER		NO	NO	
VARISTOR		NO	450NR	
NOISE SUPPRESSOR		NO	YES	
THERMOSTAT		YES(IC)	YES(IC)	
REMOTE CONTROL SWITCH (LIQUID CRYSTAL)		YES(RAR-2P2)	NO	
REFRIGERANT CHARGING VOLUME (Refrigerant 410A)	UNIT	-----	1150g	1400g
	PIPES (MAX. 20m)	WITHOUT REFRIGERANT BECAUSE COUPLING IS FLARE TYPE.		

MODEL RAF-25NH4, RAF-50NH4

1. Top and Bottom Air Blow System

During heating, this air conditioner blows warm air from the bottom as well as from the top outlet as in previous models.

When the fan speed is set to "HI" or "AUTO" for cooling, the air conditioner blows cool air from both top and bottom, which allows rapid cooling. (This top/bottom cool air blow is possible for up to 25 minutes with the fan speed set to AUTO or HI. When the set room temperature is reached, the unit automatically switches to top blow only.)

(1) AIR OUTLET SWITCH

AIR OUTLET SWITCH IS SET TO 

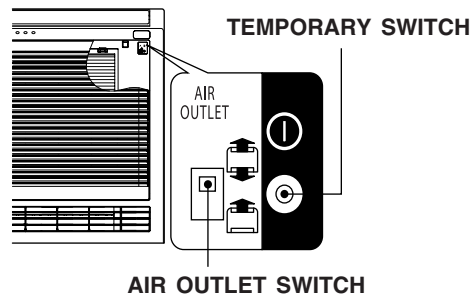

COOLING OPERATION

- If cooling is started at an AUTO or HI fan speed setting, and if a considerable difference is present between the room temperature and preset temperature, the damper inside of the bottom air outlet will automatically open to allow cold air to also be directed out of the bottom side air outlet.

When the room temperature reaches the preset temperature or after approximately 30 minutes have elapsed from starting operation, cold air will automatically be directed only from the top side air outlet.

- When it is desirable to direct cold air from the bottom side air outlet for a longer period of time, set the temperature at 16°C and fan speed at HIGH. When the room temperature is more than 8°C above the preset temperature (16°C), cold air will continuously blow from the bottom side air outlet.

HEATING OPERATION

- As operation starts, warm air is automatically discharged from top and bottom side air outlets.
- When the room temperature reaches the preset temperature, air is directed only from top side air outlet at the LOW fan speed.

DEHUMIDIFYING OPERATION

- For more efficient dehumidifying, the bottom side air outlet will remain closed.

FAN OPERATION

- Air blows out only from top side air outlet.

AIR OUTLET SWITCH IS SET TO 

- Air blows out only from top side air outlet in both heating and cooling operation.
- Air can be blown only from top side air outlet, to prevent blowing air striking your face during sleep, etc.
- If air blows out only from the top side air outlet, it takes more time to reach the set temperature when compared to air blowing from both top and bottom side air outlets. Also, temperature distribution within the room may be adversely affected. It is therefore recommended to use both top and bottom side air outlets whenever possible.

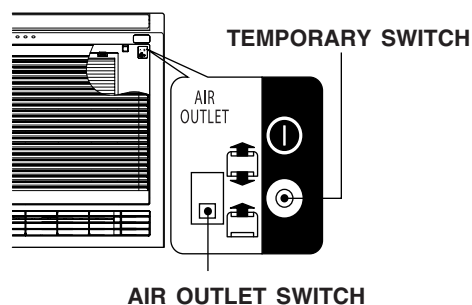

2. Damper state in each operation mode

- If the Air outlet switch is set to  , the damper at the bottom air outlet and air flow from the bottom will be as follows according to the settings of the operation switch and fan speed select buttons:

Operation	Fan speed	Damper and bottom blow-out states	When the set room temperature is reached
Cooling	AUTO	Damper opens for 25 minutes maximum and air blows from bottom. (But room temperature is more than 10°C higher than the set temperature.)	Damper closes and no air blows from bottom.
	HI	Damper opens for 25 minutes maximum and air blows from bottom. (But room temperature is more than 9°C higher than the set temperature.) However, if the temperature and fan speed are set to "16°C" and "HI" respectively, air continuously blows out from the bottom while the room temperature is more than 8°C higher than the preset temperature "16°C".	Damper closes and no air blows from bottom.
	MED or LOW	Damper stays closed and no air blows from bottom.	_____
Heating	Each speed including AUTO	Damper opens and air also blows from bottom.	Damper closes and air blows from top in ultra-low fan speed mode.
Sensor dry	Each speed including AUTO	Damper stays closed and no air blows from bottom.	The upper fan also stops.
Fan	Each speed including AUTO	Damper stays closed and no air blows from bottom.	_____
Preheating / Defrosting	Each speed including AUTO	When the HOT KEEP lamp is lit, the damper closes and no air blows from bottom.	_____

- The ratio of air discharge volume is: Upper: About 60% and Lower: About 40%.

2. Damper Mechanism

(1) Disassembly diagram of damper mechanism

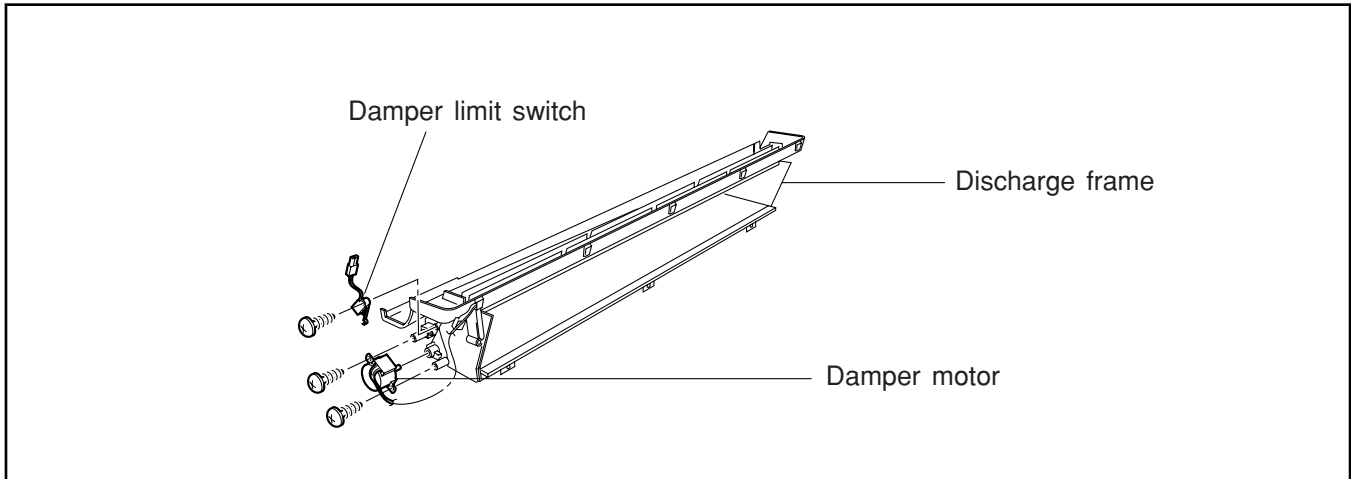

(2) Damper operation theory

The damper and the link connected to the damper moves at the same time by turning the motor.

<p>Damper closed state</p>	<p>Detailed description: This diagram shows the damper in its closed position. The damper is tilted upwards, and the link is in a vertical position. The damper limit switch is positioned to be triggered by the link's movement. The damper driving motor shaft is shown at the bottom left. The link movement direction is indicated by an arrow pointing upwards. A drain pan is shown at the top right.</p>	<p>Damper limit switch is set to ON.</p>
<p>Damper open state</p>	<p>Detailed description: This diagram shows the damper in its open position. The damper is tilted downwards, and the link is in a horizontal position. The damper limit switch is no longer triggered.</p>	<p>Damper limit switch is set to OFF.</p>

SAFETY PRECAUTION







Please read the "Safety Precaution" carefully before operating the unit to ensure correct usage of the unit. Pay special attention to signs of "▲ Warning" and "▲ Caution". The "Warning" section contains matters which, if not observed strictly, may cause death or serious injury. The "Caution" section contains matters which may result in serious consequences if not observed properly. Please observe all instructions strictly to ensure safety.

The signs indicate the following meanings. (The following are examples of signs.)



 The sign in the figure indicates prohibition.	 Indicates the instructions that must be followed.
---	---

Please keep this manual after reading.







PRECAUTIONS DURING INSTALLATION

WARNING 	<ul style="list-style-type: none"> Do not reconstruct the unit. Water leakage, fault, short circuit or fire may occur if you reconstruct the unit by yourself. 	 PROHIBITION
	<ul style="list-style-type: none"> Please ask your sales agent or qualified technician for the installation of your unit. Water leakage, short circuit or fire may occur if you install the unit by yourself. 	
	<ul style="list-style-type: none"> Please use earth line. Do not place the earth line near water or gas pipes, lightning-conductor, or the earth line of telephone. Improper installation of earth line may cause electric shock. 	 CONNECT EARTH LINE
	<ul style="list-style-type: none"> Be sure to use the specified piping set for R410A. Otherwise, this may result in broken copper pipes or faults. 	
CAUTION 	<ul style="list-style-type: none"> A circuit breaker should be installed depending on the mounting site of the unit. Without a circuit breaker, the danger of electric shock exists. 	
	<ul style="list-style-type: none"> Do not install the unit near a location where there is flammable gas. The outdoor unit may catch fire if flammable gas leaks around it. Piping shall be suitable supported with a maximum spacing of 1m between the supports. 	 PROHIBITION
	<ul style="list-style-type: none"> Please ensure smooth flow of water when installing the drain hose. 	
	<ul style="list-style-type: none"> Make sure that a single phase 230V power source is used. The use of other power sources may cause electrical components to overheat and lead to fire. 	 PROHIBITION





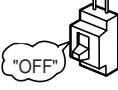









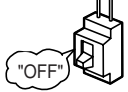

PRECAUTIONS DURING SHIFTING OR MAINTENANCE

WARNING 	<ul style="list-style-type: none"> Should abnormal situation arise (like burning smell), please stop operating the unit and remove plug from the socket. Contact your agent. Fault, short circuit or fire may occur if you continue to operate the unit under abnormal situation. 	
	<ul style="list-style-type: none"> Please contact your agent for maintenance. Improper self maintenance may cause electric shock and fire. 	
	<ul style="list-style-type: none"> Please contact your agent if you need to remove and reinstall the unit. Electric shock or fire may occur if you remove and reinstall the unit yourself improperly. 	

PRECAUTIONS DURING OPERATION

WARNING 	<ul style="list-style-type: none"> Avoid an extended period of direct air flow for your health. 	 PROHIBITION
	 PROHIBITION <ul style="list-style-type: none"> Do not put objects like thin rods into the panel of blower and suction side because the high-speed fan inside may cause danger. 	
	<ul style="list-style-type: none"> Do not use any conductor as fuse wire, this could cause fatal accident. 	 PROHIBITION
	 <ul style="list-style-type: none"> During thunder storm, disconnect the plug top and turn off the circuit breaker. 	
	<ul style="list-style-type: none"> Spray cans and other combustibles should not be located within a meter of the air outlets of both indoor and outdoor units. As a spray can's internal pressure can be increased by hot air, a rupture may result. 	 PROHIBITION

PRECAUTIONS DURING OPERATION

 CAUTION	<ul style="list-style-type: none"> The product shall be operated under the manufacturer specification and not for any other intended use. <div style="text-align: right;">  PROHIBITION </div>
	<div style="display: flex; align-items: center;">  <div style="margin-left: 20px;"> <ul style="list-style-type: none"> Do not attempt to operate the unit with wet hands, this could cause fatal accident. </div> </div> <div style="margin-top: 5px;"> DONT WET </div>
	<ul style="list-style-type: none"> When operating the unit with burning equipments, regularly ventilate the room to avoid oxygen insufficiency. <div style="text-align: right;">  STRICTLY OBSERVE PRECAUTIONS </div>
	<div style="display: flex; align-items: center;">  <div style="margin-left: 20px;"> <ul style="list-style-type: none"> Do not direct the cool air coming out from the air-conditioner panel to face household heating apparatus as this may affect the working of apparatus such as the electric kettle, oven etc. </div> </div> <div style="margin-top: 5px;"> PROHIBITION </div>
	<ul style="list-style-type: none"> Please ensure that outdoor mounting frame is always stable, firm and without defect. If not, the outdoor unit may collapse and cause danger. <div style="text-align: right;">  PROHIBITION </div>
	<div style="display: flex; align-items: center;">  <div style="margin-left: 20px;"> <ul style="list-style-type: none"> Do not wash the unit with water or place a water container such as a vase on the indoor unit. Electrical leakage could be present and cause electric shock. </div> </div> <div style="margin-top: 5px;"> PROHIBITION </div>
	<ul style="list-style-type: none"> Do not place plants directly under the air flow as it is bad for the plants. <div style="text-align: right;">  PROHIBITION </div>
	<div style="display: flex; align-items: center;">  <div style="margin-left: 20px;"> <ul style="list-style-type: none"> Be sure to stop the operation by using the remote controller and turn off the circuit breaker during cleaning, the high-speed fan inside the unit may cause danger. </div> </div>
	<ul style="list-style-type: none"> Turn off the circuit breaker if the unit is not be operated for a long period. <div style="text-align: right;">  "OFF" </div>
	<div style="display: flex; align-items: center;">  <div style="margin-left: 20px;"> <ul style="list-style-type: none"> Do not climb on the outdoor unit or put objects on it. </div> </div> <div style="margin-top: 5px;"> PROHIBITION </div>
	<ul style="list-style-type: none"> When operating the unit with the door and windows opened, (the room humidity is always above 80%) and with the air deflector facing down or moving automatically for a long period of time, water will condense on the air deflector and drips down occasionally. This will wet your furniture. Therefore, do not operate under such condition for a long time. <div style="text-align: right;">  PROHIBITION </div>
	<div style="display: flex; align-items: center;">  <div style="margin-left: 20px;"> <ul style="list-style-type: none"> If the amount of heat in the room is above the cooling or heating capability of the unit (for example: more people entering the room, using heating equipments and etc.), the preset room temperature cannot be achieved. </div> </div> <div style="margin-top: 5px;"> PROHIBITION </div>
	<ul style="list-style-type: none"> Indoor unit cleaning must be performed by authorized personnel only. Consult your sales agent. Using a commercially available detergent or similar can damage the plastic parts or clog the drain pipe, causing water to drip with potential electric shock hazard. <div style="text-align: right;">  PROHIBITION </div>
	<div style="display: flex; align-items: center;">  <div style="margin-left: 20px;">  <ul style="list-style-type: none"> Do not touch the air outlet, bottom surface and aluminum fin of the outdoor unit. You may get hurt. </div> </div> <div style="margin-top: 5px;"> DONT TOUCH </div>
<ul style="list-style-type: none"> Do not touch the refrigerant pipe and connecting valve. Burns may result. <div style="text-align: right;">   DONT TOUCH </div>	

NAMES AND FUNCTIONS OF EACH PART

INDOOR UNIT

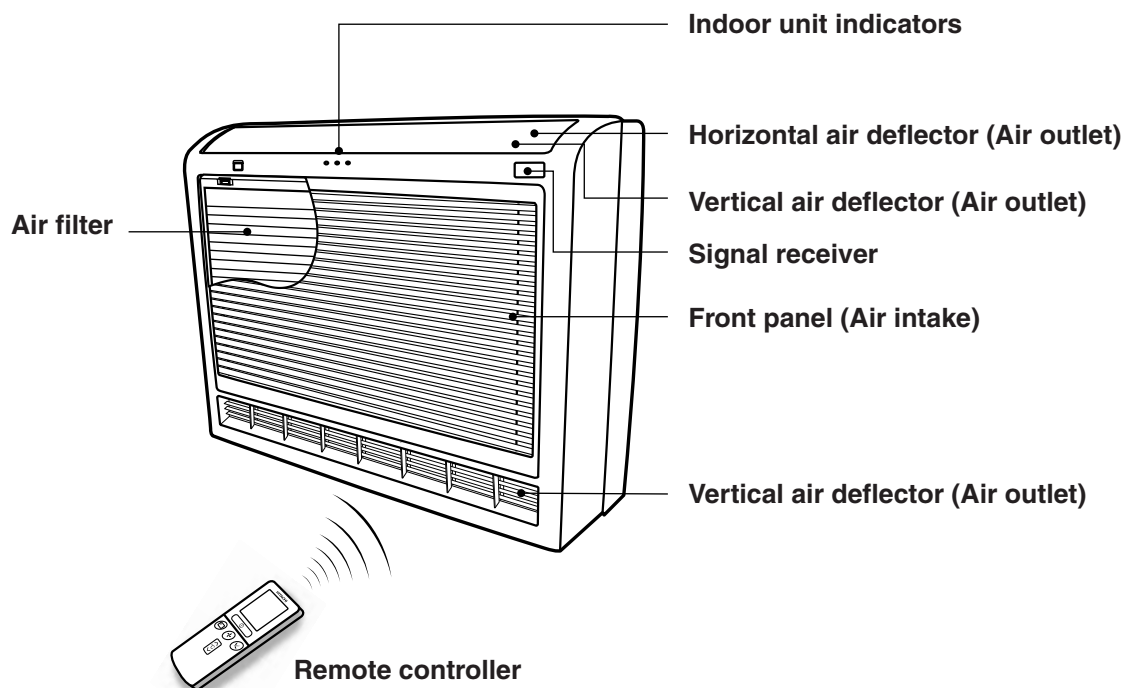

OUTDOOR UNIT

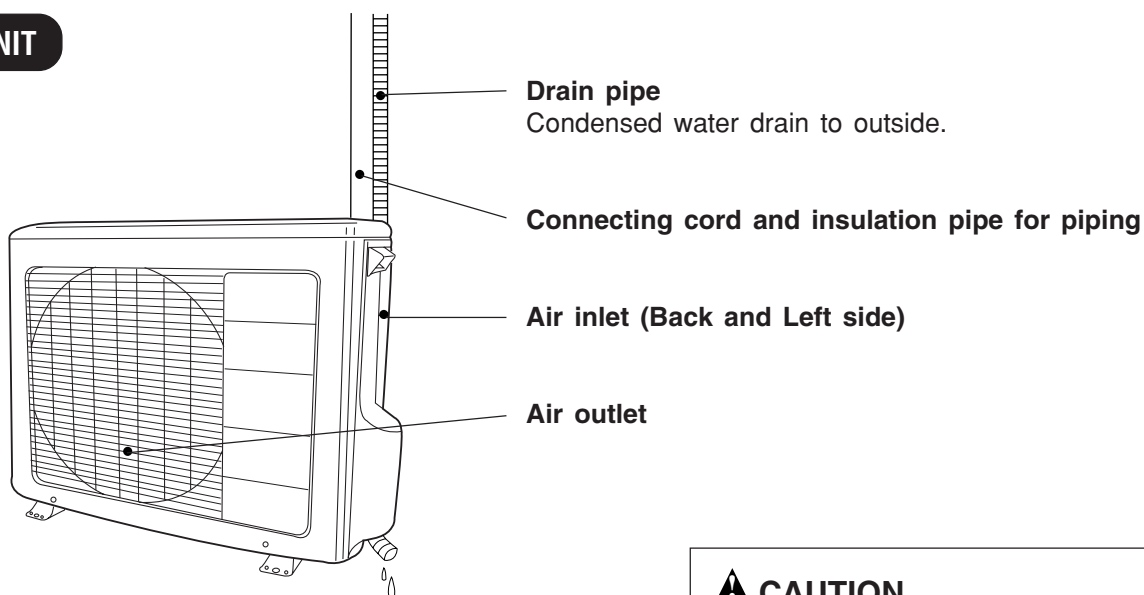

CAUTION

- When heating operation, drain or defrosted water flows out from outdoor unit. Don't close drain outlet portion in chilly area so as not to freeze these.

MODEL NAME AND DIMENSIONS

MODEL	WIDTH (mm)	HEIGHT (mm)	DEPTH (mm)
RAF-25NH4, RAF-50NH4	750	600	215
RAC-25NH4	750	570	280
RAC-50NH4	850	650	298

INDOOR UNIT CONTROL PANEL

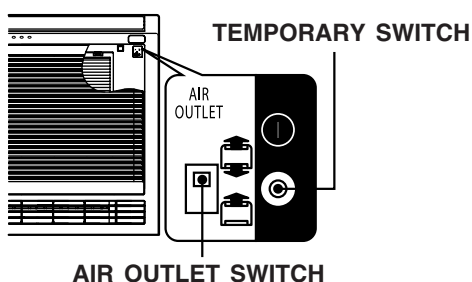

TEMPORARY SWITCH

If the remote controller does not work due to battery failure, press this switch to start and stop operation.

- This temporary operation will be at the most recent setting made. (The unit will immediately go into automatic operation once power is switched on.)

AIR OUTLET SWITCH

AIR OUTLET SWITCH IS SET TO 

COOLING OPERATION

- If cooling is started at an AUTO or HI fan speed setting, and if a considerable difference is present between the room temperature and preset temperature, the damper inside of the bottom air outlet will automatically open to allow cold air to also be directed out of the bottom side air outlet.

When the room temperature reaches the preset temperature or after approximately 30 minutes have elapsed from starting operation, cold air will automatically be directed only from the top side air outlet.

- When it is desirable to direct cold air from the bottom side air outlet for a longer period of time, set the temperature at 16°C and fan speed at HI. When the room temperature is more than 8°C above the preset temperature (16°C), cold air will continuously blow from the bottom side air outlet.

DEHUMIDIFYING OPERATION

- For more efficient dehumidifying, the bottom side air outlet will remain closed.

FAN OPERATION

- Air blows out only from top side air outlet.

AIR OUTLET SWITCH IS SET TO 

- Air blows out only from top side air outlet in both heating and cooling operation.
- Air can be blown only from top side air outlet, to prevent blowing air striking your face during sleep, etc.
- If air blows out only from the top side air outlet, it takes more time to reach the set temperature when compared to air blowing from both top and bottom side air outlets. Also, temperature distribution within the room may be adversely affected. It is therefore recommended to use both top and bottom side air outlets whenever possible.

HEATING OPERATION

- As operation starts, warm air is automatically discharged from top and bottom side air outlets.
- When the room temperature reaches the preset temperature, air is directed only from top side air outlet at the LOW fan speed.

INDOOR UNIT INDICATORS

FILTER lamp

This lamp lights when the device is operated for a total of about 100 hours, it is time to clean the filter. The lamp goes out when the "  (AUTO AWING)" button is pressed while the operation is stopped.

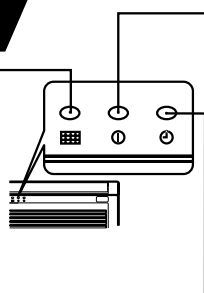

TIMER lamp

This lamp lights when the timer is working.

OPERATION lamp

This lamp lights during operation.

During heating, the operation indicator may blink, blowing very lightly or totally stopping under the following conditions:

(1) During preheating (heating operation)

For about 2~3 minutes after start up.

(2) During defrosting (heating operation)

Defrosting will be performed about once an hour when frost forms on the heat exchanger of the outdoor unit, for 5~10 minutes each time. (If the piping length used is longer than usual, frost will likely to form.)

HOW TO OPEN OR CLOSE THE FRONT PANEL

Open the front panel

- To open the front panel, use the remote controller to stop unit operation. Then press the two "  " sections below PUSH at the top left and right corners of the front panel.
- Grasp the left and right sides of the front panel and open it toward you.

Close the front panel

- To close the front panel, press the two "  " sections below PUSH at the top left and right corners of the front panel.
- Press the upper center part of the front panel to close properly.

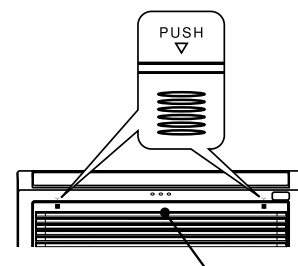

Upper center part

NAMES AND FUNCTIONS OF REMOTE CONTROL UNIT

REMOTE CONTROLLER

- This controls the operation of the indoor unit. The range of control is about 7 meters. If indoor lighting is controlled electronically, the range of control may be shorter.
This unit can be fixed on a wall using the fixture provided. Before fixing it, make sure the indoor unit can be controlled from the remote controller.
- Handle the remote controller with care. Dropping it or getting it wet may compromise its signal transmission capability.
- After new batteries are inserted into the remote controller, the unit will initially require approximately 10 seconds to respond to commands and operate.

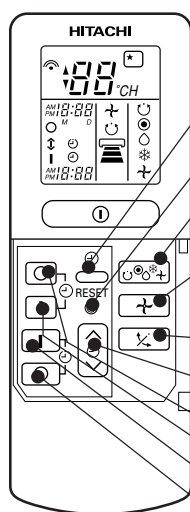
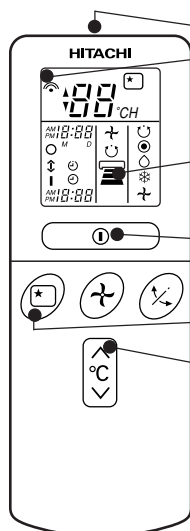

Signal emitting window/transmission sign

Point this window toward the indoor unit when controlling it. The transmission sign blinks when a signal is sent.

Display

This indicates the room temperature selected, current time, timer status, function and intensity of circulation selected.

START/STOP button

Press this button to start operation. Press it again to stop operation.

SLEEP button

Use this button to set the sleep timer.

TEMPERATURE buttons

Use these buttons to raise or lower the temperature setting. (Keep pressed, and the value will change more quickly.)

TIME button

Use this button to set and check the time and date.

RESET buttons

FUNCTION selector

Use this button to select the operating mode. Every time you press it, the mode will change from ☺ (AUTO) to ● (HEAT) to ○ (DEHUMIDIFY) to ❄ (COOL) and to ✈ (FAN) cyclically.

FAN SPEED selector

This determines the fan speed. Every time you press this button, the intensity of circulation will change from ☺ (AUTO) to 🌀 (HI) to 🌀 (MED) to 🌀 (LOW) (This button allows selecting the optimal or preferred fan speed for each operation mode).

AUTO SWING button

Controls the angle of the horizontal air deflector.

TIMER control

Use this button to set the timer.

OFF-TIMER button Select the turn OFF time.

ON-TIMER button Select the turn ON time.

RESERVE button Time setting reservation.

CANCEL button Cancel time reservation.

☺	AUTO
●	HEAT
○	DEHUMIDIFY
❄	COOL
✈	FAN
🌀 LOW MED HI	FAN SPEED
★	SLEEPING
○	STOP (CANCEL)
I	START (RESERVE)
①	START/STOP
⌚	TIME
⌚	TIMER SET
⌚ ON TIMER OFF TIMER	TIMER SELECTOR
✂	AUTO SWING

Precautions for Use

- Do not put the remote controller in the following places.
 - Under direct sunlight.
 - In the vicinity of a heater.
- Handle the remote controller carefully. Do not drop it on the floor, and protect it from water.
- Once the outdoor unit stops, it will not restart for about 3 minutes (unless you turn the power switch off and on or unplug the power cord and plug it in again).
This is to protect the device and does not indicate a failure.
- If you press the FUNCTION selector button during operation, the device may stop for about 3 minutes for protection.

VARIOUS FUNCTIONS

■ Auto Restart Control

- If there is a power failure, operation will be automatically restarted when the power is resumed with previous operation mode and airflow direction.
(As the operation is not stopped by remote controller.)
- If you intend not to continue the operation when the power is resumed, switch off the power supply.
When you switch on the circuit breaker, the operation will be automatically restarted with previous operation mode and airflow direction.

Note: 1. If you do not require Auto Restart Control, please consult your sales agent or off by remote control.
2. Auto Restart Control is not available when Timer or Sleep Timer mode is set.

AUTOMATIC OPERATION

The device will automatically determine the mode of operation, HEAT, COOL or DEHUMIDIFY depending on the initial room temperature. The selected mode of operation will change when the room temperature varies.

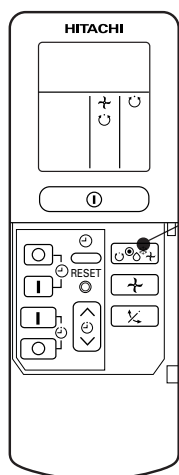



1

Press the FUNCTION selector so that the display indicates the  (AUTO) mode of operation.

- When AUTO has been selected, the device will automatically determine the mode of operation, HEAT or COOL, depending on the current room temperature.
- When AUTO is first selected, the device will determine the current room temperature and select the proper operation mode accordingly.
- When the air conditioner has adjusted the room's temperature to the near preset temperature, it will begin to monitor operation. If the room temperature subsequently changes, the air conditioner will once again select the appropriate operation (heating or cooling) to adjust the temperature to the preset temperature. The monitoring operation range is $\pm 3^{\circ}\text{C}$ relative to the preset temperature.
- If the mode automatically selected by the unit is not satisfactory, manually change the mode setting (heat, dehumidify, cool or fan).

START
STOP

Press the  (START/STOP) button.
Operation starts with a beep.
Press the button again to stop operation.

- As the settings are stored in memory in the remote controller, you only have to press the  (START/STOP) button next time.

You can raise or lower the temperature setting as necessary by maximum of 3°C .

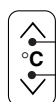

Press the temperature button and the temperature setting will change by 1°C each time.

- The preset temperature and the actual room temperature may vary somewhat depending on conditions.

Press the  (FAN SPEED) button, AUTO, LOW and SILENT is available.

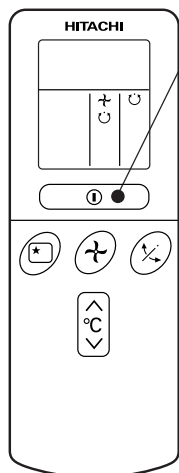

HEATING OPERATION

- Use the device for heating when the outdoor temperature is under 21°C. When it is too warm (over 21°C), the heating function may not work in order to protect the device.
- In order to keep reliability of the device, please use this device above -15°C of the outdoor temperature.

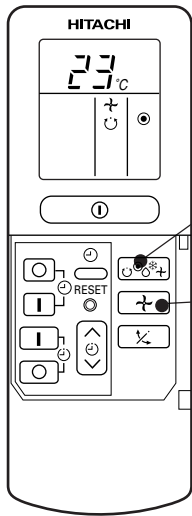

1

Press the FUNCTION selector so that the display indicates ● (HEAT).

2

Set the desired FAN SPEED with the ↗ (FAN SPEED) button (the display indicates the setting).

⌚ (AUTO): The fan speed changes automatically to the temperature of the air which blows out.

🔊 (HI) : Economical as the room will become warm quickly. But you may feel a chill at the beginning.

🔊 (MED) : Quiet.

🔊 (LOW) : More quiet.

3

Set the desired room temperature with the TEMPERATURE buttons (the display indicates the setting).

The temperature setting and the actual room temperature may vary somewhat depending on conditions.

**START
STOP**

Press the ⏻ (START/STOP) button. Heating operation starts with a beep. Press the button again to stop operation.

- As the settings are stored in memory in the remote controller, you only have to press the ⏻ (START/STOP) button next time.

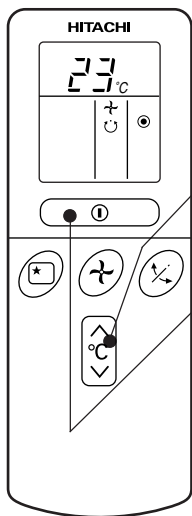

DEHUMIDIFYING OPERATION

Use the device for dehumidifying when the room temperature is over 16°C.
When it is under 15°C, the dehumidifying function will not work.

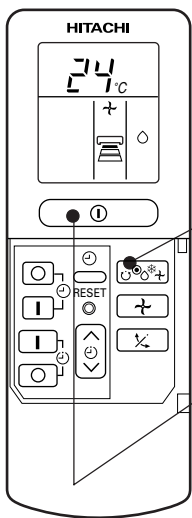

1 Press the FUNCTION selector so that the display indicates ◊ (DEHUMIDIFY).
The FAN SPEED is set at LOW automatically.
The FAN SPEED button does not work.

START STOP Press the ① (START/STOP) button.

- When you want to change the operation mode, please use the FUNCTION selector.
- Set the desired temperature is available.
- You also can use the FUNCTION selector to select this operation.

Dehumidifying Function

When the room temperature is higher than the temperature setting: The device will dehumidify the room, reducing the room temperature to the preset level.

When the room temperature is lower than the temperature setting: Dehumidifying will be performed at the temperature setting slightly lower than the current room temperature, regardless of the temperature setting. The function will stop (the indoor unit will stop emitting air) as soon as the room temperature becomes lower than the setting temperature.

COOLING OPERATION

Use the device for cooling when the outdoor temperature is 22-42°C.
If indoors humidity is very high (80%), some dew may form on the air outlet grille of the indoor unit.

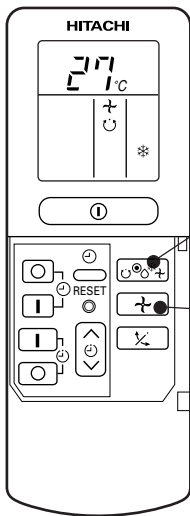

1

Press the FUNCTION selector so that the display indicates * (COOL).

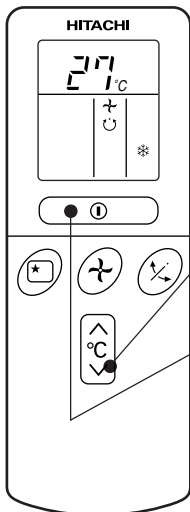

2

Set the desired FAN SPEED with the (FAN SPEED) button (the display indicates the setting).

(AUTO): The FAN SPEED is HI at first and varies to MED automatically when the preset temperature has been reached.

(HI) : Economical as the room will become cool quickly.

(MED) : Quiet.

(LOW) : More quiet.

3

Set the desired room temperature with the TEMPERATURE button (the display indicates the setting).

The temperature setting and the actual room temperature may vary somewhat depending on conditions.

**START
STOP**

Press the (START/STOP) button. Cooling operation starts with a beep. Press the button again to stop operation. The cooling function does not start if the temperature setting is higher than the current room temperature (even though the (OPERATION) lamp lights). The cooling function will start as soon as you set the temperature below the current room temperature.

As the settings are stored in memory in the remote controller, you only have to press the (START/STOP) button next time.

FAN OPERATION

You can use the device simply as an air circulator. Use this function to dry the interior of the indoor unit at the end of summer.

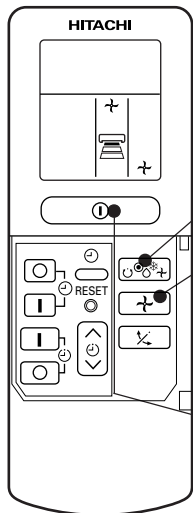

1

Press the FUNCTION selector so that the display indicates (FAN).

2

Press the (FAN SPEED) button.

(HI) : The strongest air blow.

(MED) : Quiet.

(LOW) : More quiet.

**START
STOP**

Press the (START/STOP) button. Fan operation starts with a beep. Press the button again to stop operation.

FAN SPEED (AUTO)

..... When the AUTO fan speed mode is set in the cooling/heating operation:

For the heating operation	<ul style="list-style-type: none"> ● The fan speed will automatically change according to the temperature of discharged air. ● As room temperature reaches the preset temperature, a very light breeze will blow.
For the cooling operation	<ul style="list-style-type: none"> ● Operation starts in the "HI" mode to reach the preset temperature. ● As room temperature approaches the preset temperature, fan speed automatically switches to "LOW".

HOW TO SET THE SLEEP TIMER

Set the current time at first if it is not set before (see the pages for setting the current time). Press the  (SLEEP) button, and the display changes as shown below.

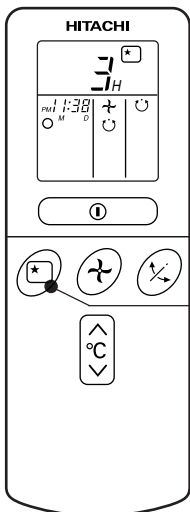

• SLEEP

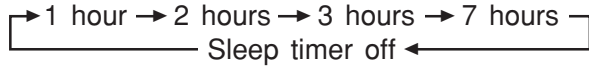
Mode	Indication
Sleep Timer	 → 1 hour → 2 hours → 3 hours → 7 hours → Sleep timer off ←

Sleep Timer: The device will continue working for the designated number of hours and then turn off. Point the signal window of the remote controller toward the indoor unit, and press the SLEEP button. The timer information will be displayed on the remote controller. The TIMER lamp lights with a beep from the indoor unit. When the sleep timer has been set, the display indicates the turn-off time.

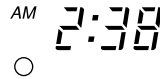

Example: If you set 3 hours sleep time at 11:38 p.m., the turn-off time is 2:38 a.m.

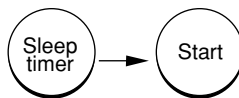

The device will be turned off by the sleep timer and turned on by on-timer.

1 Set the ON-timer.

2 Press the  (SLEEP) button and set the sleep timer.

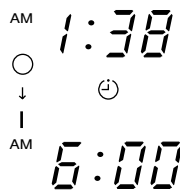
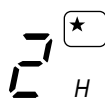



For heating:

In this case, the device will turn off in 2 hours (at 1:38 a.m.) and it will be turned on at 6:00 next morning.

How to Cancel Reservation

Point the signal window of the remote controller toward the indoor unit, and press the  (CANCEL) button.

The  (RESERVED) sign goes out with a beep and the  (TIMER) lamp turns off on the indoor unit.

HOW TO SET THE TIMER

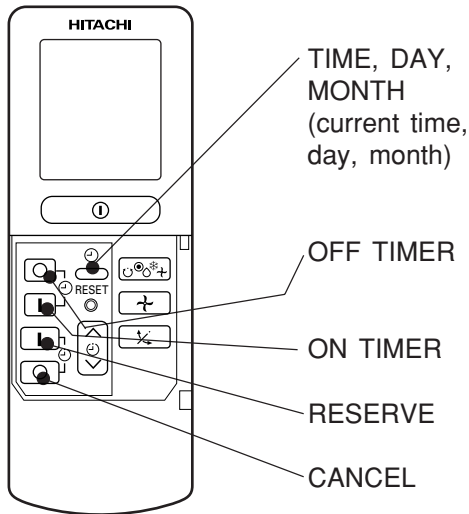

Time, Day, Month

After you change the batteries;

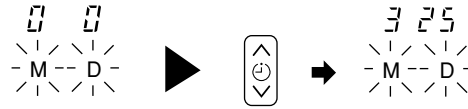

1 Set the current month and day with the TIMER control button.

OFF-Timer

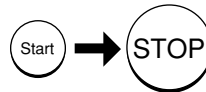

You can set the device to turn off at the present time.

1 Press the (OFF-TIMER) button. The (OFF) mark blinks on the display.

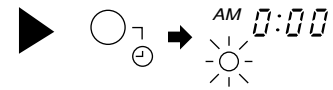

ON-Timer

- The device will turn on at the designated times.

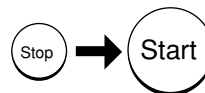

1 Press the (ON-TIMER) button. The (ON) mark blinks on the display.

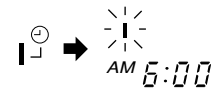

ON/OFF-Timer

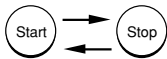

- The device will turn on (off) and off (on) at the designated times.
- The switching occurs first at the preset time that comes earlier.
- The arrow mark appearing on the display indicates the sequence of switching operations.

1 Press the (ON-OFF) button so that the (OFF) mark blinks.

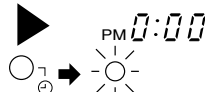

2 Set the turn-off time with the TIMER control button. Press the (RESERVE) button.

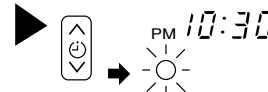

3 Press the (ON-TIMER) button so that the (OFF) mark lights and the (ON) mark blinks.

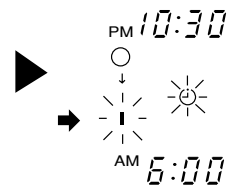

How to Cancel Reservation

Point the signal window of the remote controller toward the indoor unit, and press the (CANCEL) button.

The (RESERVED) sign goes out with a beep and the (TIMER) lamp turns off on the indoor unit.

NOTE

You can set only one of the OFF-timer, ON-timer and ON/OFF-timer.

2 Press the ⊖ (TIME) button.



3 Set the current time with the TIMER control button.

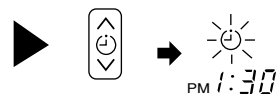

4 Press the ⊖ (TIME) button again. The time indication starts lighting instead of flashing.

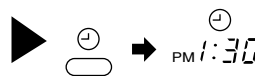

- The time indication will disappear automatically in 10 second.
- To check the current time setting, press the ⊖ (TIME) button twice.

The setting of the current time is now complete.

Example: The current time is 1:30 p.m.

2 Set the turn-off time with the TIMER control button.

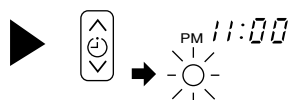

3 Point the signal window of the remote controller toward the indoor unit, and press the | (RESERVE) button.

The ○ (OFF) mark starts lighting instead of flashing and the sign ⊖ (RESERVED) lights. A beep occurs and the ⊖ (TIMER) lamp lights on the indoor unit.

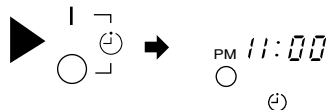

Example: The device will turn off at 11:00p.m.
The setting of turn-off time is now complete.

2 Set the turn-on time with the TIMER control button.

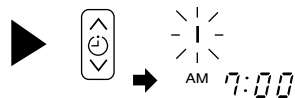

3 Point the signal window of the remote controller toward the indoor unit, and press the | (RESERVE) button.

The | (ON) mark starts lighting instead of flashing and the ⊖ (RESERVED) sign lights. A beep occurs and the ⊖ (TIMER) lamp lights on the indoor unit.

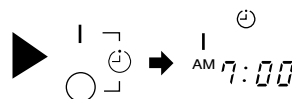

Example:
The device will turn on at 7:00 a.m.
The setting of the turn-on time is now complete.

4 Set the turn-on time with the TIMER control button.

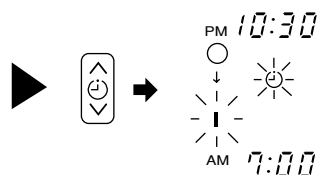

5 Point the signal window of the remote controller toward the indoor unit, and press the | (RESERVE) button.

The | (ON) mark starts lighting instead of flashing and the ⊖ (RESERVED) sign lights. A beep occurs and the ⊖ (TIMER) lamp lights on the indoor unit.

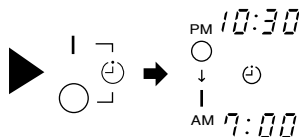



Example:
The device will turn off at 10:30 p.m. and it will be turned on at 7:00 a.m.
The settings of the turn-on/off times are now complete.

- The timer may be used in three ways: off-timer, on-timer, and ON/OFF (OFF/ON)-timer. Set the current time at first because it serves as a reference.
- As the time settings are stored in memory in the remote controller, you only have to press the | (RESERVE) button in order to use the same settings next time.

ADJUSTING THE AIR DEFLECTOR

1 Adjustment of the conditioned air in the upward and downward directions.

The horizontal air deflector is automatically set to the proper angle suitable for each operation. The deflector can be swung up and down continuously and also set to the desired angle using the “ (AUTO SWING)” button.

- If the “ (AUTO SWING)” button is pressed once, the horizontal air deflector swings up and down. If the button is pressed again, the deflector stops in its current position.
- Use the horizontal air deflector within the adjusting range shown in the right figure.
- When the “ (AUTO SWING)” button is pressed while the operation is stopped, the horizontal air deflector moves and stops at the position where the air outlet closes.
- When the auto swing operation is performed, if the horizontal air deflector is moved manually, the swinging range may drift. However, it will return to the original operation range after a short time.

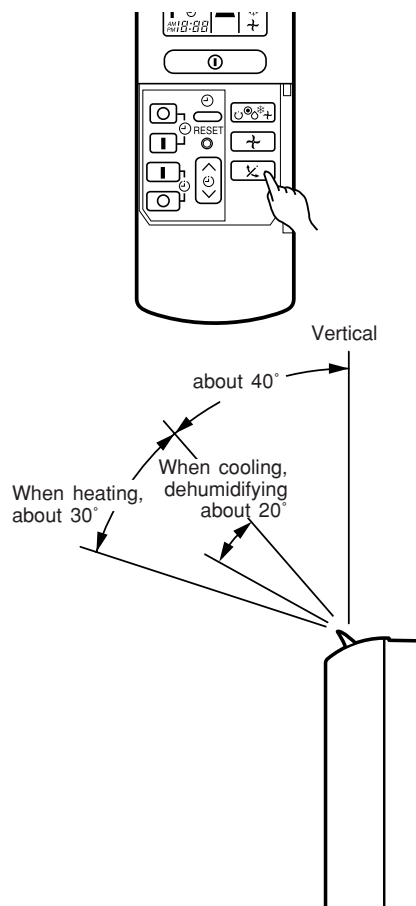

Vertical air deflector

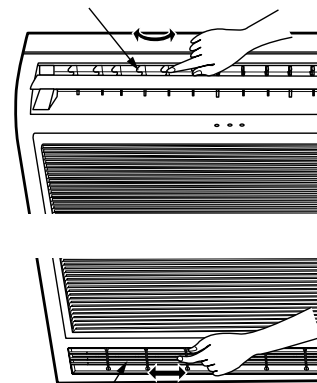

Vertical air deflector

2 Adjustment of the conditioned air to the left and right.

Hold the vertical air deflector as shown in the figure and adjust the conditioned air to the left and right.

CAUTION

- When operating the unit in cooling operation with the air deflector facing down and moving automatically for a long period of time, water will be condensed on the air deflector and drips down occasionally. This will wet your furniture.

HOW TO CHANGE THE BATTERIES IN THE REMOTE CONTROLLER

1 Remove the cover as shown in the figure and remove the old batteries.

2 Install the new batteries.
The direction of the batteries should match the marks in the case.

⚠ CAUTION

1. Do not mix new and old batteries, or different type of batteries together.
2. Remove the batteries when you do not use the remote controller for 2 or 3 months.

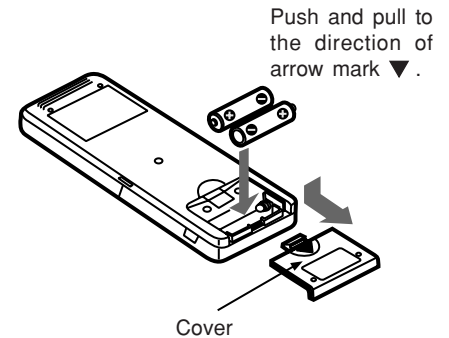

TEMPORARY SWITCH

If the remote controller does not work due to battery failure, press this switch to start and stop operation.

- This temporary operation will be at the setting made most recently. (The unit will immediately go into automatic operation once power is switched on.)

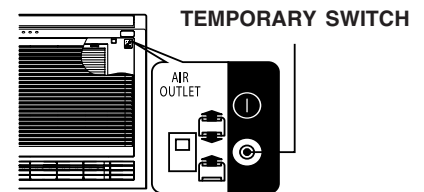

CIRCUIT BREAKER

When you do not use the room air conditioner, set the circuit breaker to "OFF".

HOW TO USE THE AIR CONDITIONER EFFECTIVELY

1. An average room temperature setting is probably the best for you as well as being economical.

- Excessive cooling or heating is not recommended for health reasons. High electricity bills may also result.
- Close the curtains or blinds to prevent heat from flowing into or escaping the room as well as to make more effective use of electricity.



2. At intervals, the doors and windows should be opened to let fresh air in.

Make sure the room is ventilated when operating the air conditioner at the same time as other heating appliances.



⚠ CAUTION

3. Using the timer is recommended before going to sleep or going out.

4. The following must never be used for cleaning the indoor and outdoor units:

- Benzine, thinner and scrub can damage plastic surfaces or coating.
- Hot water above 40°C can shrink the filter and deform plastic parts.



5. Do not block the air intake and air outlet.

- Do not block the air outlets and intakes of the indoor and outdoor units with curtains or other obstacles which could degrade air conditioner performance and cause unit failure.

MAINTENANCE

⚠ WARNING

- Before cleaning, stop unit operation with the remote controller and turn off the circuit breaker.

⚠ CAUTION

- Do not expose the unit to water as it may cause an electric shock.
- For cleaning inside the air conditioner, consult your sales agent.
- Avoid using detergent when cleaning the heat exchanger of the indoor unit. Unit failure may result.
- When cleaning the heat exchanger with a vacuum cleaner, make sure to wear gloves so as not to injure your hands on the heat exchanger fins.

1. AIR FILTER

Clean the air filter, as it removes dust inside the room.

Be sure to clean the filter once every two weeks so as not to consume electricity unnecessarily.

PROCEDURE

1 Open the front panel.

- To open the front panel, use the remote controller to stop unit operation. Then press the two "≡" sections below PUSH at the top left and right corners of the front panel.
- Grasp the left and right sides of the front panel and open it toward you.

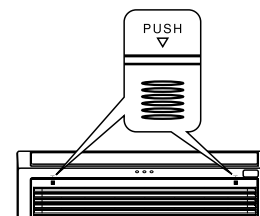

2 Remove the filters.

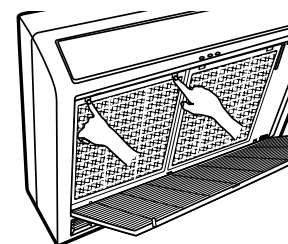

3 Remove dust of the filters using a vacuum cleaner.

- After using neutral detergent, wash with clean water and dry in shade.

4 Attach the filter.

- Attaching the filters which are placed the surface written "FRONT" up.



5 Close the front panel.

- To close the front panel, press the two "≡" sections below PUSH at the top left and right corners of the front panel.
- Press the upper center part of the front panel to close properly.

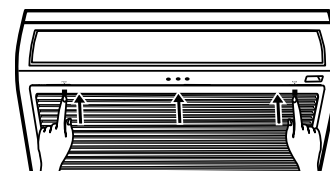

⚠ CAUTION

- Do not wash with hot water at more than 40°C. The filter may shrink.
- When washing it, shake off moisture completely and dry it in the shade; do not expose it directly to the sun. The filter may shrink.
- Don't operate the unit without filter. Fault may occur if you continue.

2. HOW TO INSTALL AND REMOVE THE FRONT PANEL

- Be sure to use both hands to grasp the front panel when removing it or attaching it.
- The front panel may be installed up or down to suit user preference.

Removing

- Press the hook found at the tip of the resin band installed inside the front panel's right section to remove the resin band.
- Pull the front panel down toward you and once fully open, pull it to remove.

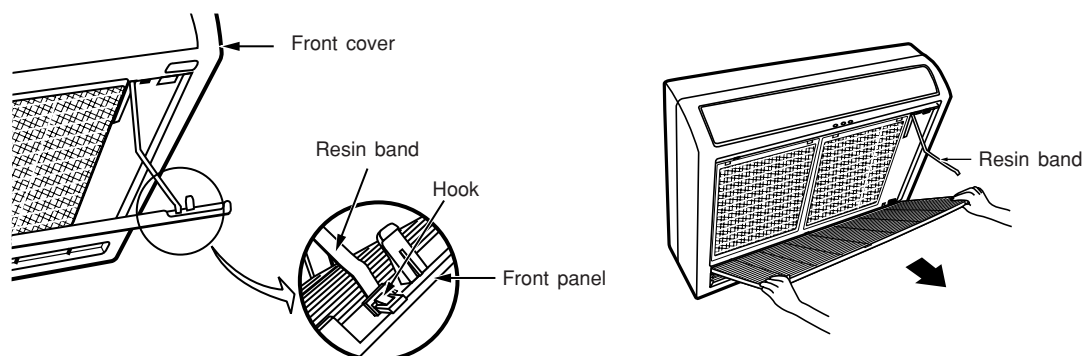

Attaching

- Attach three front panel bearings to the axis of the front cover. (Set the hook to face up.)
- Insert the tip of the resin band into the hole of the protrusion inside the right section of the front panel

3. CLEANING OF FRONT PANEL

The front panel can be washed in water. It can be kept clean at all times.

- Front panel can be removed and washed in water. Gently clean the front panel using a soft sponge.
- When the air conditioner is to be cleaned without removing the front panel, clean both the body and remote controller with a dry soft cloth.
- Wipe off water completely. If water remains on the display section or light receiver section, this could cause a malfunction.

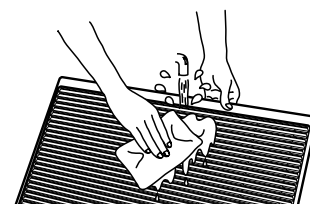

CAUTION

- Do not splash or direct water to the body of the unit when cleaning it as this may cause short circuit.
- Never clean with hot water (above 40°C), benzene, gasoline, acid, thinner or a brush, because it will damage the plastic surface and the coating.



4. MAINTENANCE AT BEGINNING OF LONG OFF PERIOD

- Activating air conditioner drying will keep the interior of the indoor unit dry and prevent mold formation.
- Turn off the circuit breaker.

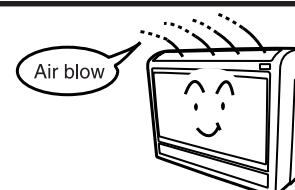

OPTIONAL PARTS

1. AIR CLEANSING AND DEODORIZING FILTERS (SPX-CFH5)

- The air cleansing and deodorizing filters can absorb even minute dust particles. The filter's antibacteria function prevents growth of microorganisms in the filter. The air cleansing and deodorizing filters also add air purification to the unit's normal operation to offer a clean and comfortable environment.
- When installing the air cleansing and deodorizing filters, remove the air filters and attach them onto the hooks of the front cover frame.
- The cooling capacity is slightly weakened and the cooling speed becomes slower when the air cleansing and deodorizing filters are used. So, set the fan speed to "HIGH" when using it in this condition.
- The air cleansing and deodorizing filters is washable and reusable up to 20 times by using vacuum cleaner or water rinse under running tap water.



INFORMATION

CAPABILITIES

Heating Capability

- This room air conditioner utilizes a heat pump system that absorbs exterior heat and brings it into a room to be heated. As the ambient temperature gets lower, heating capability will also lower. In such a situation, the PAM and inverter work to increase compressor rpm to keep the unit's heating capability from decreasing. If the unit's heating performance is still unsatisfactory, other heating appliances should be used to augment this unit's performance.
- The air conditioner is designed to heat an entire room so that it may take some time before you feel warm. Timer operation is recommended for effective preheating ahead of the desired time.

Cooling and Dehumidifying Capabilities

- If the heat present in a room exceeds the unit's cooling capacity (for example, if there are many people in the room or other heating appliances are used), the preset room temperature may not be reached.



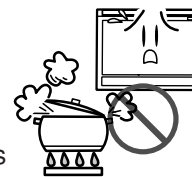

CAUTION

Do not use a stove or any other high-temperature devices in proximity to the indoor unit.





PROHIBITION

VARIOUS FUNCTIONS



- When fan speed, room temperature are set with the remote controller before starting manual operation and the buttons are released, the indication of settings will go off in 10 seconds and only the operation mode will be displayed.
- Pressing the  button while the unit is in operation will let the protective circuit work so that the unit will not operate for approximately 3 minutes.
- During heating operation, the indoor unit's color indicator lamp may flash with no air emitted for a while.
- If you feel cold wind during warming operation with the  (HI) fan speed or want to make the unit operation quieter after the room is heated, use of  (AUTO) setting is recommended.
- With the  (LOW) setting, the unit's cooling capability will lower slightly.

TIMER PROGRAMMING/SLEEP TIMER OPERATION

- When the timer has been programmed, the unit will not operate even if the set time is reached unless the unit receives a signal from the remote controller. Confirm that timer programming is complete (beep) and the TIMER lamp of the indoor unit lights.
- If the  (SLEEP) button is pressed while the ON/OFF timer is programmed, the sleep timer takes priority.
- During sleep timer operation, the fan speed sets to  (LOW) regardless of the preset speed. The remote controller display indication will remain unchanged even with the  (LOW) setting.

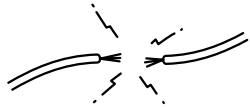

REGULAR INSPECTION

PLEASE CHECK THE FOLLOWING POINTS EITHER EVERY HALF YEARLY OR YEARLY. CONTACT YOUR SALES AGENT SHOULD YOU NEED ANY HELP.

1		⚠ WARNING	Check to see if the unit's earth line has been connected correctly. If the earth line is disconnected or faulty, unit failure or electric shock hazard may result.
2		⚠ WARNING	Check to see if the mounting frame has rusted excessively or if the outdoor unit has tilted or become unstable. It could collapse or fall, causing injury.

AFTER SALES SERVICE AND WARRANTY

WHEN ASKING FOR SERVICE, CHECK THE FOLLOWING POINTS.

CONDITION	CHECK THE FOLLOWING POINTS
<p>If the remote controller is not transmitting a signal. (Remote controller display is dim or blank.)</p> 	<ul style="list-style-type: none"> ● Do the batteries need replacement? ● Is the polarity of the inserted batteries correct?
<p>When it does not operate.</p> 	<ul style="list-style-type: none"> ● Is the fuse all right? ● Is the voltage extremely high or low? ● Is the circuit breaker "ON"? ● Is the setting of operation mode different from other indoor units?
<p>When it does not cool well. When it does not heat well.</p> 	<ul style="list-style-type: none"> ● Is the air filter blocked with dust? ● Is the set temperature suitable? ● Have the top and bottom air deflectors been adjusted to their correct positions according to the operation mode selected? ● Are the air inlets or air outlets of indoor and outdoor units blocked? ● Is the fan speed "LOW"?

The following phenomena do not indicate unit failure.

During heating, the operation indicator blinks and air blow stops	<p><Operation start> The unit is preparing to blow warm air. Please wait.</p> <p><In operation> The outdoor unit is defrosting. Please wait.</p>
Hissing or fizzy sounds	Refrigerant flow noise in the pipe or valve sound generated when flow rate is adjusted.
Squeaking noise	Noise generated when the unit expands or contracts due to temperature changes.
Rustling noise	Noise generated with the indoor unit fan's rpm changing such as operation start times.
Clicking noise	Noise of the motorized valve when the unit is switched on.
Perking noise	Noise of the ventilation fan sucking in air present in the drain hose and blowing out dehumidifying water that had accumulated in the condensed water collector. For details, consult your sales agent.
Changing operation noise	Operation noise changes due to power variations according to room temperature changes.
Mist emission	Mist is generated as the air within the room is suddenly cooled by conditioned air.

Steam emitted from the outdoor unit	Water generated during defrosting operation evaporates and steam is emitted.
Odors	Caused as the smells and particles of smoke, food, cosmetics, etc. present in room air become attached the unit and blown off into the room again.
The outdoor unit continues to operate even if operation is stopped.	Defrosting is underway (as the heating operation is stopped, the microcomputer checks frost accumulated in the indoor unit and instructs the unit to perform automatic defrosting if necessary).
The OPERATION lamp is blinking.	Shows preheating or defrosting operation is underway. As the protective circuit or preheat sensor operates when unit operation is stopped during preheating and then restarted, or when operation mode is switched from cooling to heating, the lamp continues to blink.
Does not reach the temperature setting.	Actual room temperature may deviate slightly from the remote controller's temperature setting depending on the number of people in the room, indoor or outdoor conditions when the air conditioner is used for more than one room at the same time.

- If the unit still fails to operate normally after performing the above inspections, turn the circuit breaker off and contact your sales agent immediately.

Contact your sales agent immediately if the following phenomena should occur:



- The circuit breaker switches off or the fuse blows frequently.
 - The switch operation is not stable.
 - Foreign matter or water accidentally enters the unit interior.
 - The power cord gets excessively hot or its insulation is torn or stripped.
 - TIMER lamp on the indoor unit display blinks.
- As the nature of the failure can be identified by the blinking cycle, check the blinking cycle before turning off the circuit breaker.



Notes

- In quiet operation or stopping the operation, the following phenomena may occasionally occur, but they are not abnormal for the operation.
 - (1) Slight flowing noise of refrigerant in the refrigerating cycle.
 - (2) Slight rubbing noise from the fan casing which is cooled and then gradually warmed as operation stops.
- The odor will possibly be emitted from the room air conditioner because the various odor, emitted by smoke, foodstuffs, cosmetics and so on, sticks to it. So the air filter and the evaporator regularly must be cleaned to reduce the odor.

- Please contact your sales agent immediately if the air conditioner still fails to operate normally after the above inspections. Inform your agent of the model of your unit, production number, date of installation. Please also inform him regarding the fault.

Please note:

On switching on the equipment, particularly when the room light is dimmed, a slight brightness fluctuation may occur. This is of no consequence.
The conditions of the local Power Supply Companies are to be observed.

CONSTRUCTION AND DIMENSIONAL DIAGRAM

MODEL RAF-25NH4, RAF-50NH4

Unit: mm

Wireless remote controller

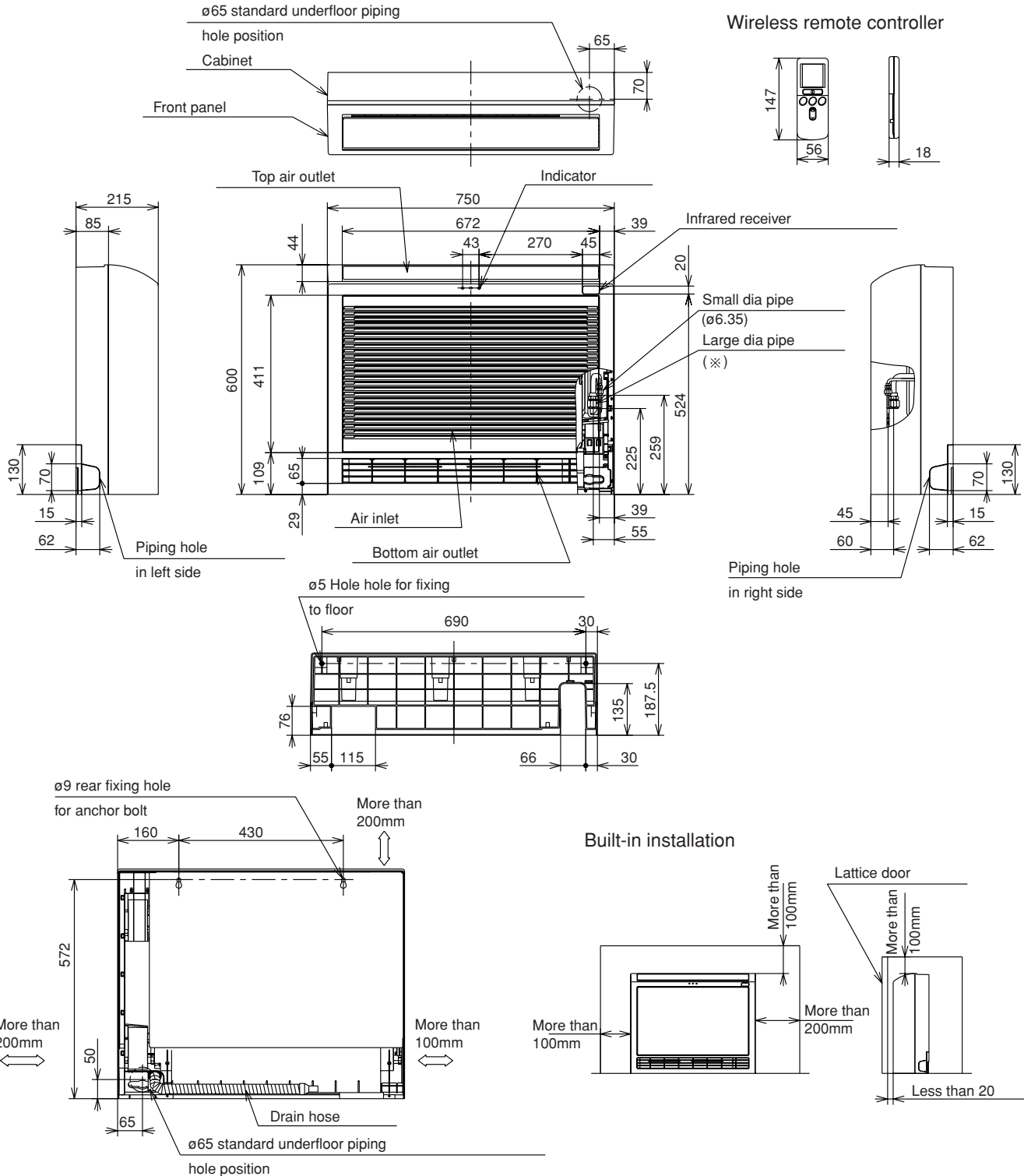
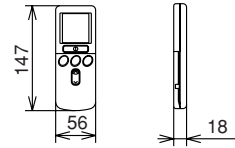

Cautions:

1. Use insulated pipes for both large and small diameters.
 2. Make sure the difference in heights between the indoor and outdoor units is 10m.
 3. For built-in installation, make sure that the infrared receiver and indicator are not blocked.
 4. Pipes can be laid out from the right, bottom or rear, when the unit is viewed from front.
 5. Keep the clearance shown by \longleftrightarrow for installation.
 6. For built-in installation, keep the vertical deflector at the top air outlet as flat as possible.
If it is inclined too much, heat will be trapped in the unit, which could cause faulty room temperature.
 7. An connection cable 1.6mm or 2.0mm dia.x2 (control side) is used for the connection cable.
- \times RAF-25NH4 $\rightarrow \phi 9.52$, RAF-50NH4 $\rightarrow \phi 12.7$

CONSTRUCTION AND DIMENSIONAL DIAGRAM FOR OUTDOOR MODEL RAC-25NH4

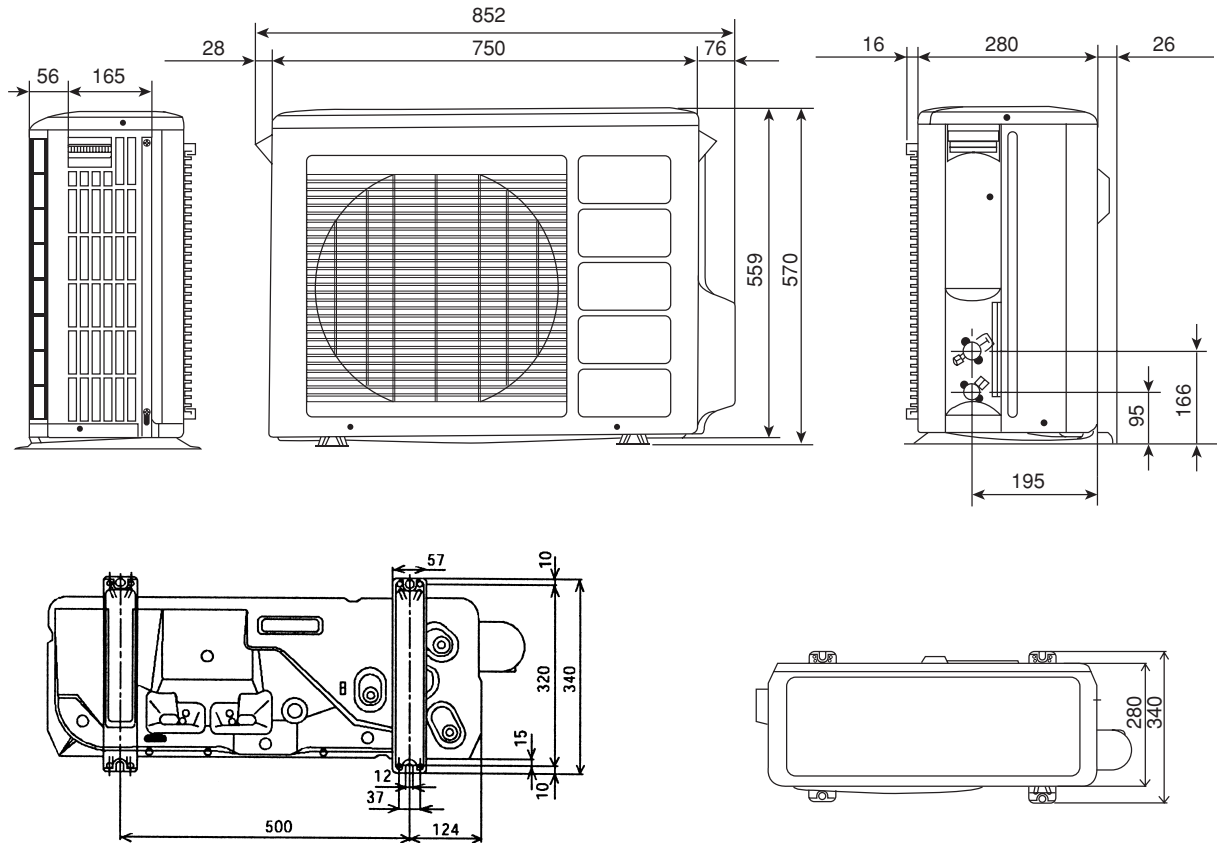

MODEL RAC-50NH4

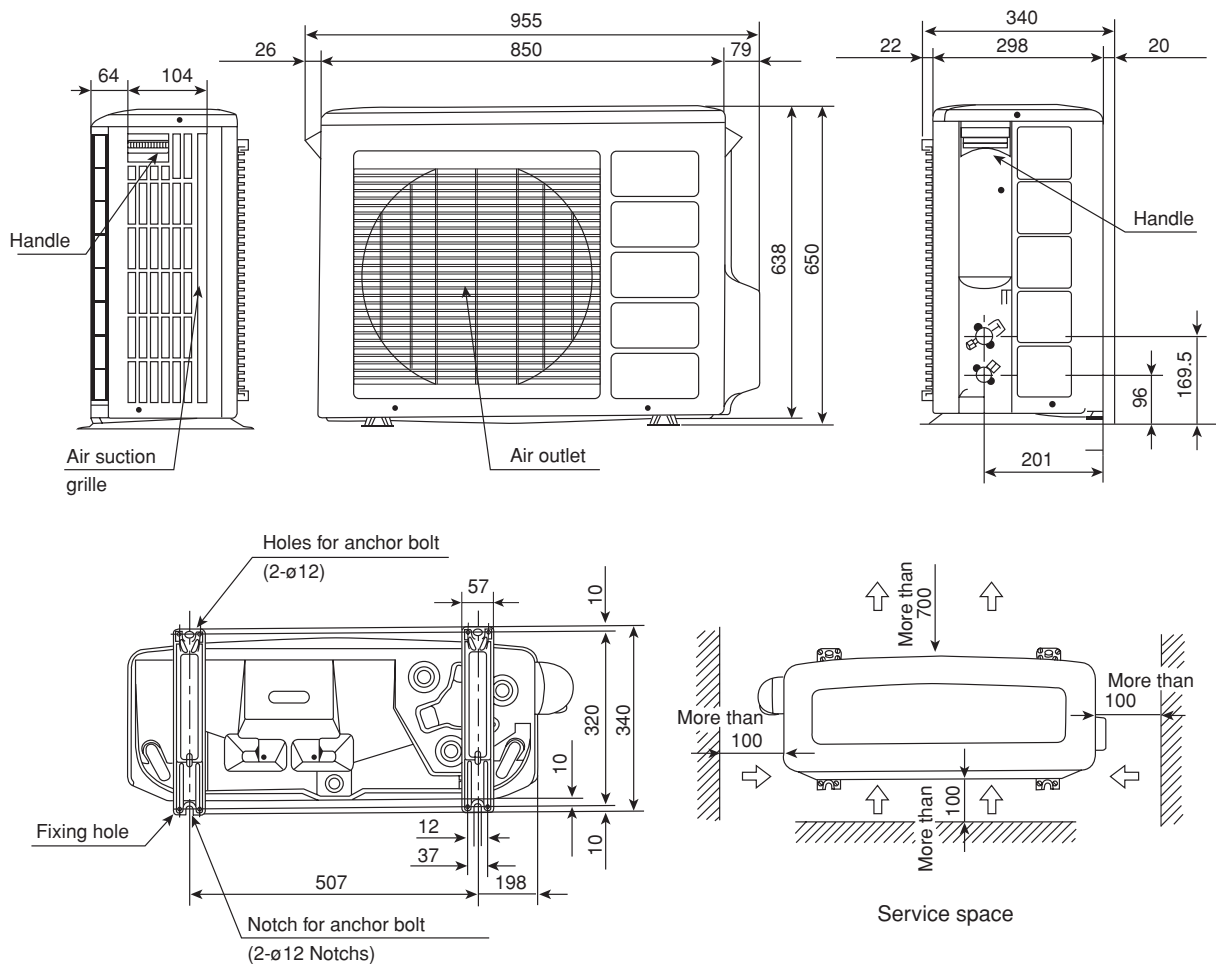

MAIN PARTS COMPONENT

THERMOSTAT

Thermostat Specifications

MODEL			RAF-25NH4, RAF-50NH4	
THERMOSTAT MODEL			IC	
OPERATION MODE			COOL	HEAT
TEMPERATURE °C (°F)	INDICATION 16	ON	15.7 (60.3)	19.0 (66.2)
		OFF	15.0 (59.0)	19.7 (67.5)
	INDICATION 24	ON	23.7 (74.7)	27.0 (80.6)
		OFF	23.0 (73.4)	27.7 (81.9)
	INDICATION 32	ON	31.7 (89.1)	35.0 (95.0)
		OFF	31.0 (87.8)	35.7 (96.3)

FAN MOTOR

Fan Motor Specifications

MODEL	RAF-25NH4, RAF-50NH4
POWER SOURCE	DC : 5V, DC : 0-35V
OUTPUT	20W (MAX40)
CONNECTION	<p>(Control circuit built in)</p>

BLU : BLUE YEL : YELLOW BRN : BROWN WHT : WHITE
 GRY : GRAY ORN : ORANGE GRN : GREEN RED : RED
 BLK : BLACK PNK : PINK VIO : VIOLET

COMPRESSOR MOTOR

Compressor Motor Specifications

MODEL	RAC-25NH4	RAC-50NH4
COMPRESSOR MODEL	JU1012D	JU1013D
PHASE	SINGLE	
RATED VOLTAGE	AC 220 ~ 230 V	
RATED FREQUENCY	50 Hz	
POLE NUMBER	4	
CONNECTION		
RESISTANCE VALUE (Ω)	20°C (68°F)	2M = 1.05
	75°C (167°F)	2M = 1.28

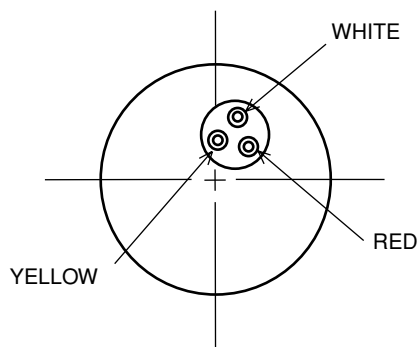

⚠ CAUTION

When the refrigerating cycle has been operated for a long time with the capillary tubes clogged or crushed or with too little refrigerant, check the color of the refrigerating machine oil inside the compressor. If the color has been changed conspicuously, replace the compressor.

WIRING DIAGRAM

MODEL RAF-25NH4 / RAC-25NH4
RAF-50NH4 / RAC-50NH4

INDOOR UNIT

BLU : BLUE YEL : YELLOW BRN : BROWN WHT : WHITE
GRY : GRAY ORN : ORANGE GRN : GREEN RED : RED
BLK : BLACK PNK : PINK VIO : VIOLET

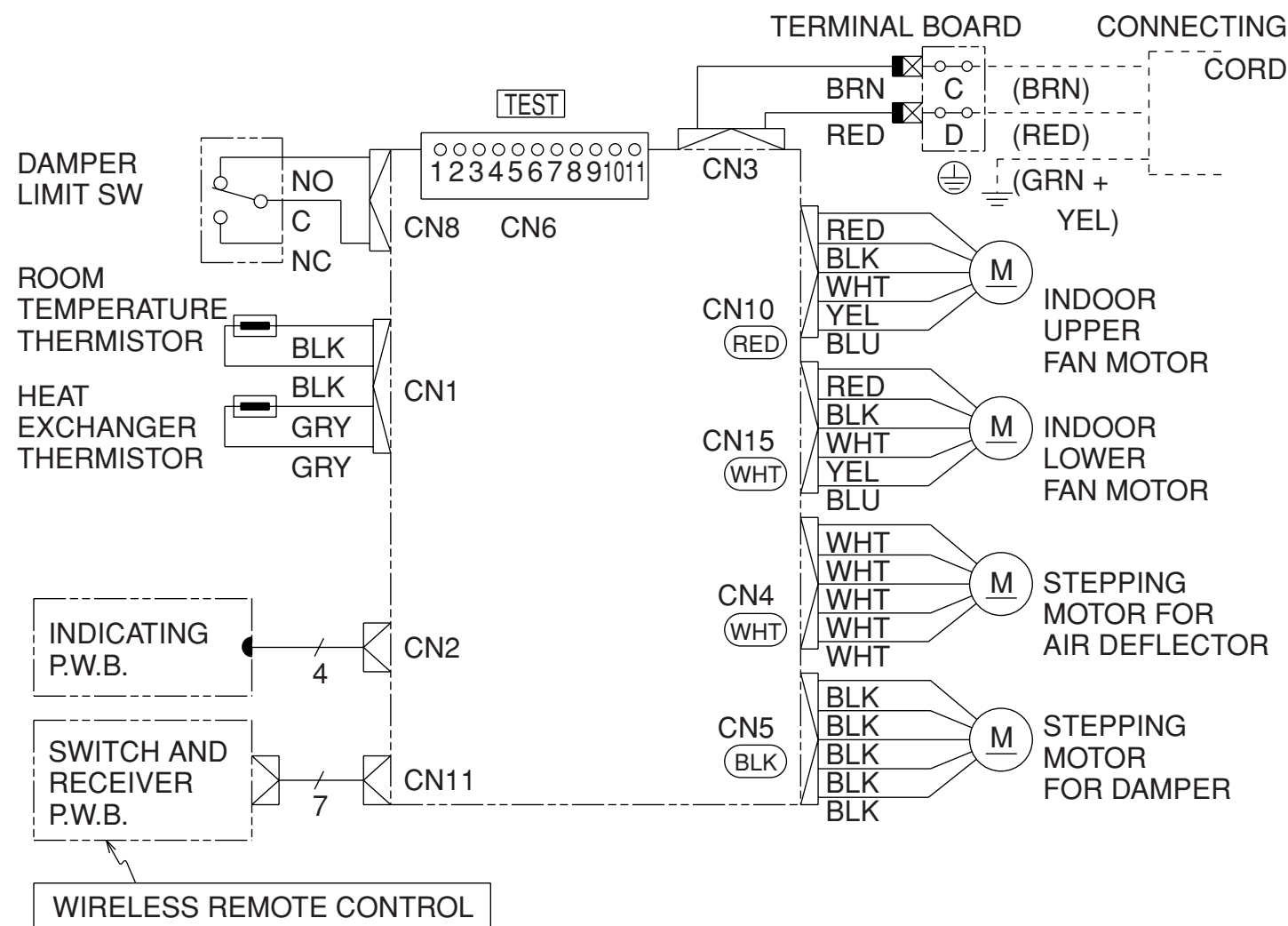

OUTDOOR UNIT

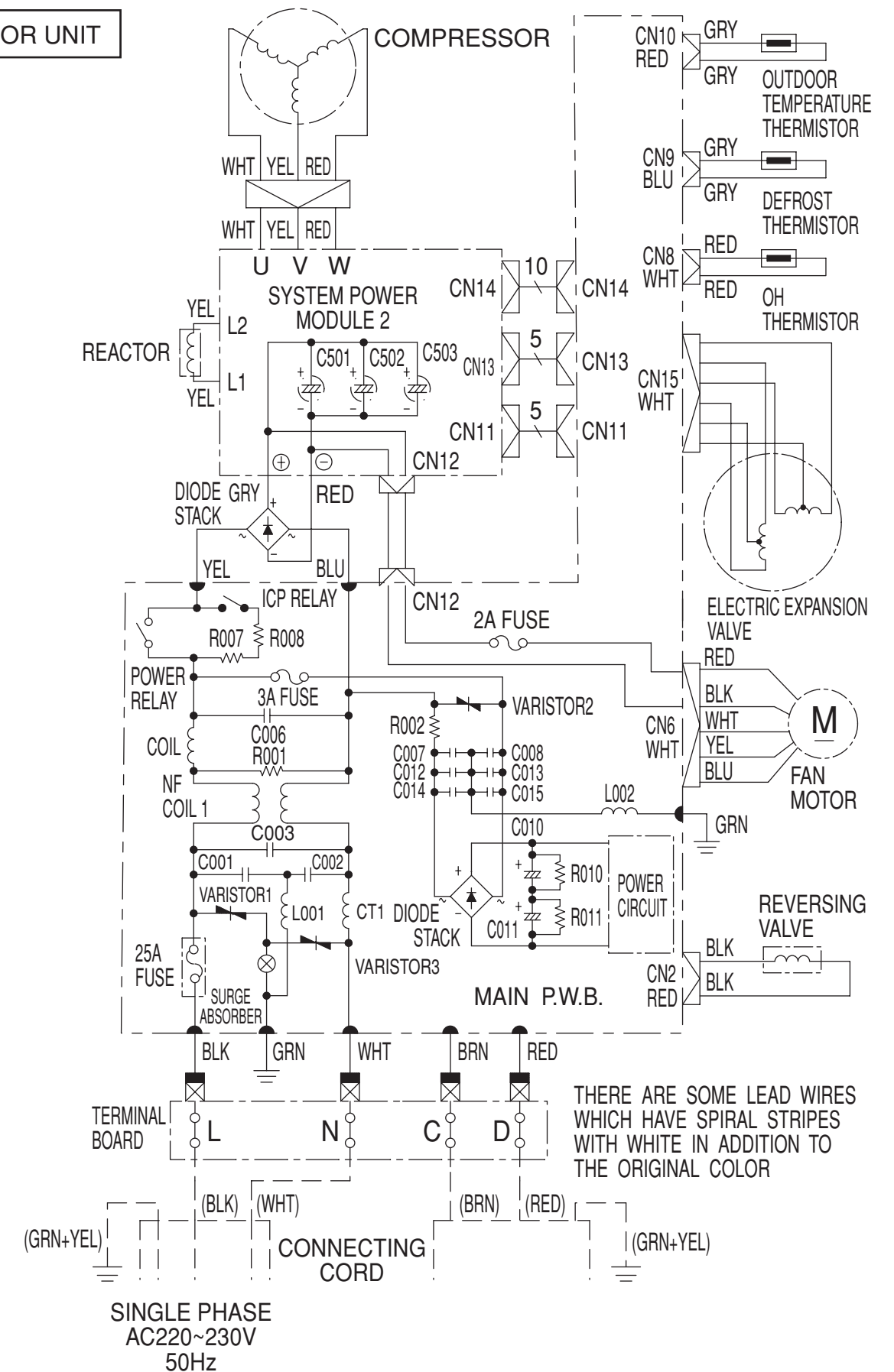

MODEL		RAF-25NH4	RAF-50NH4
NO.	LABEL NAME	REQUIRED OF UNIT SIDE	REQUIRED OF UNIT SIDE
000	WMAX	4400 min-1	5100 min-1
001	WMAX 2	4500 min-1	5100 min-1
002	WSTD	3400 min-1	5100 min-1
003	WJKMAX	3000 min-1	4000 min-1
004	WBEMAX	2800 min-1	3500 min-1
005	CMAX	2700 min-1	4800 min-1
006	CMAX 2	2800 min-1	4800 min-1
007	CSTD	2450 min-1	4550 min-1
008	CKYMAX	2200 min-1	4000 min-1
009	CJKMAX	1800 min-1	3000 min-1
00A	CBEMAX	1600 min-1	2000 min-1
01F	SDMAX	1600 min-1	2000 min-1
020	SDRPM	1500 min-1	1900 min-1
026	WMIN	1500 min-1	1800 min-1
027	CMINHI	1500 min-1	1800 min-1
028	CMIN	1500 min-1	1800 min-1
029	DMIN	1500 min-1	1800 min-1
02A	STAROTP	5 °C	5 °C
02B	STARCP	2000 min-1	2000 min-1
02C	STARCPH	3000 min-1	3000 min-1
02E	STARTMW	60 sec	60 sec
02F	STARTMC	60 sec	60 sec
031	PKOU	500 min-1	500 min-1
032	FZZY_GN	1.0	1.0
033	FZZYTM	3 min	3 min
039	SHIFTW	2.33 °C	2.33 °C
03A	SFTSZW	0.66 °C	0.66 °C
03B	SHIFTC	-0.66 °C	-0.66 °C
03C	SHIFTD	-0.66 °C	-0.66 °C
03D	CLMXTP	30.00 °C	30.00 °C
03E	YNEOF	20.00 °C	20.00 °C
043	TEION	5.00 °C	5.00 °C
044	TEIOF	12.00 °C	12.00 °C
04F	TDTMPH	27.00 °C	27.00 °C
050	TDTMPM	25.00 °C	25.00 °C
051	TDTMPL	20.00 °C	20.00 °C
053	TDSFNP	12.66 °C	12.66 °C
054	TDSFLH	4.66 °C	4.66 °C
057	DFTIM1	45 min	45 min
058	DFTIM2	60 min	90 min
059	DFTIM3	90 min	60 min
05A	TDF411	60 sec	60 sec
05B	TDF412	30 sec	30 sec
05C	TDF413	60 sec	60 sec
05D	DFRPM3	1500 min-1	1500 min-1
05E	DFMXTM	20 min	20 min
05F	DFMAX	5600 min-1	5600 min-1
060	TDF421	150 sec	150 sec
061	TDF422	2000 min-1	2000 min-1
062	TDF431	90 sec	90 sec
068	DEFCOL	5 min	5 min
0C0	FWSS	400 min-1	400 min-1
0C1	FWSOY	710 min-1	820 min-1
0C2	FWS	710 min-1	820 min-1
0C3	FWKAF	790 min-1	950 min-1
0C4	FWL	790 min-1	950 min-1
0C5	FWAH	830 min-1	1040 min-1
0C6	FWH	870 min-1	1080 min-1
0C7	FWHM	960 min-1	1100 min-1
0C8	FWHH	960 min-1	1100 min-1
0C9	FCSOY	670 min-1	670 min-1
0CA	FCS	670 min-1	730 min-1
0CB	FCL	750 min-1	920 min-1
0CC	FCAH	790 min-1	1000 min-1
0CD	FCH	830 min-1	1050 min-1
0CE	FCHM	880 min-1	1090 min-1
0CF	FCHH	880 min-1	1090 min-1
0D5	FDOY	670 min-1	700 min-1
0D6	FDS1	670 min-1	790 min-1
0D7	FDS2	670 min-1	790 min-1
0D8	FCLN	600 min-1	600 min-1
0DE	FWOPN	960 min-1	1250 min-1
0DF	FCOPN	880 min-1	1090 min-1
0E0	FWCLD	960 min-1	1250 min-1
0E1	FCCLD	880 min-1	1090 min-1

MODEL		RAF-25NH4	RAF-50NH4
NO.	LABEL NAME	REQUIRED OF UNIT SIDE	REQUIRED OF UNIT SIDE
0E2	FWUDSS	400 min-1	400 min-1
0E3	FWUDSOY	640 min-1	740 min-1
0E4	FWUDS	640 min-1	740 min-1
0E5	FWUDKAF	710 min-1	860 min-1
0E6	FWUDL	710 min-1	860 min-1
0E7	FWUDAH	750 min-1	950 min-1
0E8	FWUDH	780 min-1	970 min-1
0E9	FWUDHH	870 min-1	990 min-1
0EA	FCUDSOY	600 min-1	660 min-1
0EB	FCUDS	600 min-1	660 min-1
0EC	FCUDL	680 min-1	820 min-1
0ED	FCUDAH	710 min-1	900 min-1
0EE	FCUDH	750 min-1	940 min-1
0EF	FCUDHH	790 min-1	980 min-1
0F5	FWUDOPN	870 min-1	1100 min-1
0F6	FCUDOPN	790 min-1	980 min-1

Table 1 Fan speed by mode

Operation mode	Fan speed mode		Label name	
Heating operation	Upper Fan	Ultra Lo	FWSS	
		Sleep	FWSOY	
		Lo	FWS	
		Overload	FWKAF	
		Med	FWL	
		Hi	Set fan speed "Hi"	FWH
		Ultra Hi	(When AIR OUTLET SWITCH "ON")	FWHM
	Lower Fan	Ultra Hi	(When AIR OUTLET SWITCH "OFF")	FWHH
		Hi	Set fan speed "AUTO"	FWAH
		Ultra Lo	FWUDSS	
		Sleep	FWUDSOY	
		Lo	FWUDS	
		Overload	FWUDKAF	
		Med	FWUDL	
Cooling operation	Upper Fan	Hi	Set fan speed "Hi"	FWUDH
		Ultra Hi	(When AIR OUTLET SWITCH "ON")	FWUDHH
		Ultra Hi	(When AIR OUTLET SWITCH "OFF")	FWUDAH
		Hi	Set fan speed "AUTO"	FWUDAH
		Sleep	FCSOY	
	Lower Fan	Lo	FCS	
		Med	FCL	
		Hi	Set fan speed "Hi"	FCH
		Ultra Hi	(When AIR OUTLET SWITCH "ON")	FCHM
		Ultra Hi	(When AIR OUTLET SWITCH "OFF")	FCHH
Dehumidifying operation	Upper Fan	Hi	Set fan speed "AUTO"	FCAH
		Sleep	FCUDSOY	
		Lo	FCUDS	
	Lower Fan	Med	FCUDL	
		Hi	Set fan speed "Hi"	FCUDH
		Ultra Hi	(When AIR OUTLET SWITCH "ON")	FCUDHH
Dehumidifying operation	Lower Fan	Hi	Set fan speed "AUTO"	FCUDAH
		Sleep	FDOY	
Dehumidifying operation	Lower Fan	Lo 1	FDS1	
		Lo 2	FDS2	

Table 2 Room temperature shift value

Operation mode	Fan speed mode	Shift value
Heating operation	Fan speed "AUTO, Hi, Med"	SHIFTW
	Fan speed "Lo, Sleep"	SFTSZW
Cooling operation		SHIFTC
Dehumidifying operation		SHIFTD

CIRCUIT DIAGRAM

Remote Controller (RAR-2P2)

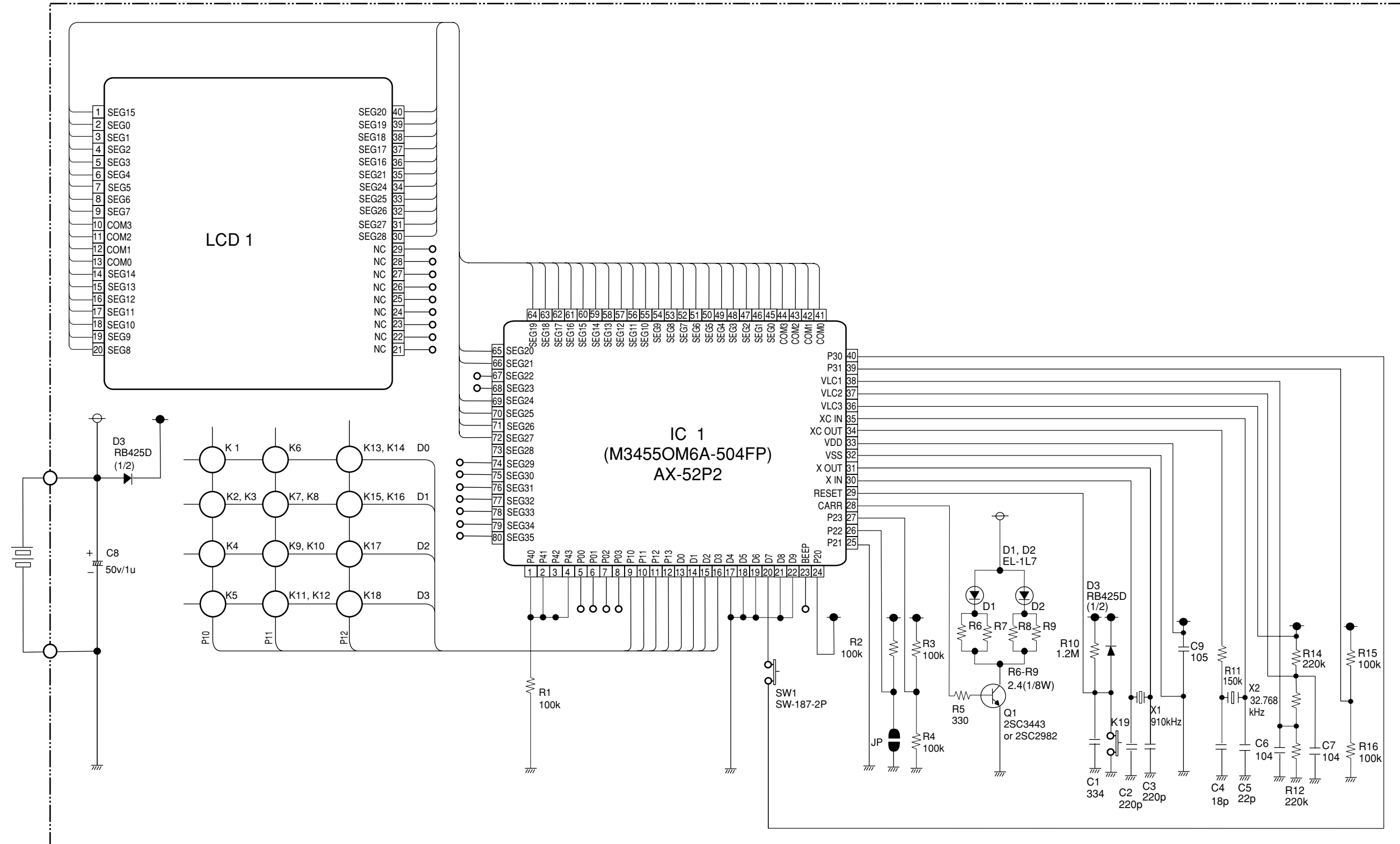

Key matrix table

input \ output	D0	D1	D2	D3
P10	Door open Start/Stop	Operation selection	Fan speed selection	—
	Door shut Start/Stop	Dry	—	—
P11	Door open On timer	Hour up	Hour down	Dry • present time
	Door shut	Room temperature up	Room temperature down	—
P12	Door open Off timer	—	Reservation	Cancel
	Door shut Sleep	—	—	—
P13	Door open	—	—	—
	Door shut	—	—	—

CIRCUIT DIAGRAM

MODEL RAF-25NH4, RAF-50NH4

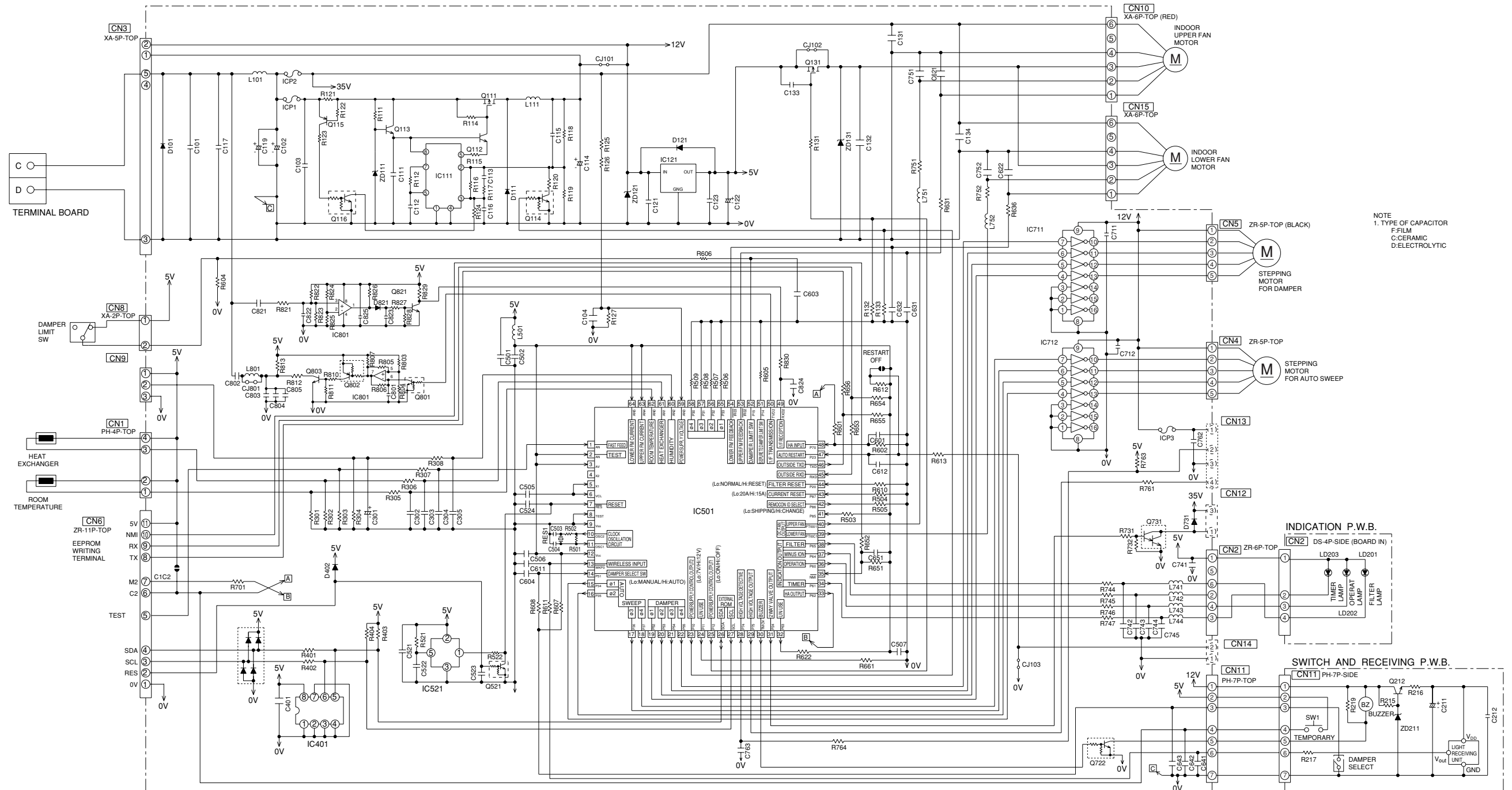

NOTE
1. TYPE OF CAPACITOR
F: FILM
C: CERAMIC
D: ELECTROLYTIC

RESISTOR

SYMBOL	RETER	VALUE
Ω	LIMIT	W
R111	27K	±5% 1/10W
R112	30K	±5% 1/16W
R114	750	±5% 1.8W
R115	560	±5% 1.8W
R116	560	±5% 1.8W
R117	68K	±5% 1/16W
R118	79K	±5% 1/16W
R119	6.8K	±5% 1/16W
R120	10K	±5% 1/16W
R121	0.56	±5% 1/4W
R122	100	±5% 1/16W
R123	33K	±5% 1/16W
R124	10K	±5% 1/16W
R125	30K	±5% 1/16W
R126	30K	±5% 1/16W
R127	5.1K	±5% 1/16W
R131	5.1K	±5% 1/16W
R132	10K	±5% 1/16W
R133	10K	±5% 1/16W
R215	2.7K	±5% 1/10W
R216	47	±5% 1/10W
R217	1K	±5% 1.8W
R219	3.3K	±5% 1/10W
R301	12.7K	±1% 1/16W
R302	12.7K	±1% 1/16W
R303	10K	±5% 1/16W
R304	100K	±1% 1/16W

SYMBOL	RETER	VALUE
Ω	LIMIT	W
R305	1K	±5% 1/16W
R306	1K	±5% 1/16W
R307	1K	±5% 1/16W
R308	1K	±5% 1/16W
R401	390	±5% 1/16W
R402	390	±5% 1/16W
R403	5.1K	±5% 1/16W
R404	5.1K	±5% 1/16W
R501	1M	±5% 1/16W
R502	0	±5% 1/16W
R503	10K	±5% 1/16W
R504	10K	±5% 1/16W
R505	10K	±5% 1/16W
R506	10K	±5% 1/16W
R507	10K	±5% 1/16W
R508	10K	±5% 1/16W
R509	10K	±5% 1/16W
R521	1M	±5% 1/16W
R522	1K	±5% 1/16W
R601	1K	±5% 1/16W
R602	10K	±5% 1/16W
R604	10K	±5% 1/16W
R605	10K	±5% 1/16W
R606	1K	±5% 1/16W

SYMBOL	RETER	VALUE
Ω	LIMIT	W
R607	10K	±5% 1/16W
R608	1K	±5% 1/16W
R610	10K	±5% 1/16W
R611	1K	±5% 1/16W
R612	10K	±5% 1/16W
R613	1K	±5% 1/16W
R631	1K	±5% 1/16W
R636	1K	±5% 1/16W
R651	1K	±5% 1/16W
R652	100	±5% 1/16W
R653	1K	±5% 1/16W
R654	10K	±5% 1/16W
R655	10K	±5% 1/16W
R656	1K	±5% 1/16W
R661	10K	±5% 1/16W
R662	10K	±5% 1/16W
R701	1K	±5% 1/16W
R731	2.7K	±5% 1/16W
R732	10K	±5% 1/16W
R744	300	±5% 1/10W
R745	300	±5% 1/10W

SYMBOL	RETER	VALUE
Ω	LIMIT	W
R746	300	±5% 1/10W
R747	300	±5% 1/10W
R751	2.7K	±5% 1/16W
R752	2.7K	±5% 1/16W
R761	100	±5% 1/16W
R763	10K	±5% 1/16W
R764	1K	±5% 1/16W
R803	120K	±5% 1/16W
R804	120K	±5% 1/16W
R805	120K	±5% 1/16W
R806	120K	±5% 1/16W
R807	4.3K	±5% 1/16W
R810	680	±5% 1/10W
R811	2K	±5% 1/16W
R812	39	±5% 1.8W
R813	39	±5% 1.8W
R821	1K	±5% 1/16W
R822	10K	±1% 1/16W
R823	10K	±1% 1/16W
R824	8.25K	±1% 1/16W
R825	10K	±1% 1/16W
R826	1K	±5% 1/16W
R827	3K	±5% 1/16W
R828	10K	±5% 1/16W

SYMBOL	RETER	VALUE
Ω	LIMIT	W
R829	5.1K	±5% 1/16W
R830	1K	±5% 1/16W

SYMBOL	RETER	VALUE
F	V	TYPE
C101	0.22μ	55V F
C102	330μ	50V D
C103	470p	830V C
C104	0.1μ	25V C
C111	2.2μ	10V C
C112	1000p	50V C
C113	0.047μ	25V C
C114	220μ	25V D
C115	1000p	50V C
C116	50V	F
C117	55V	F
C119	50V	D
C121	0.1μ	25V C
C122	100μ	10V D
C123	0.1μ	25V C
C131	0.22μ	50V C
C132	0.1μ	25V C
C133	0.1μ	25V C
C134	0.22μ	50V C
C211	47μ	16V D
C212	0.1μ	25V C
C301	22μ	4V D
C302	0.1μ	25V C
C303	0.1μ	25V C

SYMBOL	RETER	VALUE
F	V	TYPE
C304	0.1μ	25V C
C305	0.1μ	25V C
C401	0.1μ	25V C
C501	0.1μ	25V C
C502	0.1μ	25V C
C503	12p	50V C
C504	12p	50V C
C505	0.1μ	25V C
C506	0.1μ	25V C
C507	0.1μ	25V C
C601	0.1μ	25V C
C602	0.1μ	25V C
C603	0.1μ	25V C
C604	0.1μ	25V C
C605	0.1μ	25V C
C606	0.1μ	25V C
C607	0.1μ	25V C
C608	0.1μ	25V C
C609	0.1μ	25V C
C610	0.1μ	25V C
C611	0.1μ	25V C
C612	0.1μ	25V C
C613	0.1μ	25V C
C614	0.1μ	25V C
C615	0.1μ	25V C
C616	0.1μ	25V C
C617	0.1μ	25V C
C618	0.1μ	25V C
C619	0.1μ	25V C
C620	0.1μ	25V C
C621	0.1μ	25V C
C622	0.1μ	25V C
C623	0.1μ	25V C
C624	0.1μ	25V C
C625	0.1μ	25V C
C626	0.1μ	25V C
C627	0.1μ	25V C
C628	0.1μ	25V C
C629	0.1μ	25V C
C630	0.1μ	25V C
C631	0.1μ	25V C
C632	0.1μ	25V C
C633	0.1μ	25V C
C634	0.1μ	25V C
C635	0.1μ	25V C
C636	0.1μ	25V C
C637	0.1μ	25V C
C638	0.1μ	25V C
C639	0.1μ	25V C
C640	0.1μ	25V C
C641	0.1μ	25V C
C642	0.1μ	25V C
C643	0.1μ	25V C
C644	0.1μ	25V C
C645	0.1μ	25V C
C646	0.1μ	25V C
C647	0.1μ	25V C
C648	0.1μ	25V C
C649	0.1μ	25V C
C650	0.1μ	25V C
C651	0.1μ	25V C
C652	0.1μ	25V C
C653	0.1μ	25V C
C654	0.1μ	25V C
C655	0.1μ	25V C
C656	0.1μ	25V C
C657	0.1μ	25V C
C658	0.1μ	25V C
C659	0.1μ	25V C
C660	0.1μ	25V C
C661	0.1μ	25V C
C662	0.1μ	25V C
C663	0.1μ	25V C
C664	0.1μ	25V C
C665	0.1μ	25V C
C666	0.1μ	25V C
C667	0.1μ	25V C
C668	0.1μ	25V C
C669	0.1μ	25V C
C670	0.1μ	25V C
C671	0.1μ	25V C
C672	0.1μ	25V C
C673	0.1μ	25V C
C674	0.1μ	25V C</

CIRCUIT DIAGRAM

MODEL RAC-25NH4, RAC-50NH4

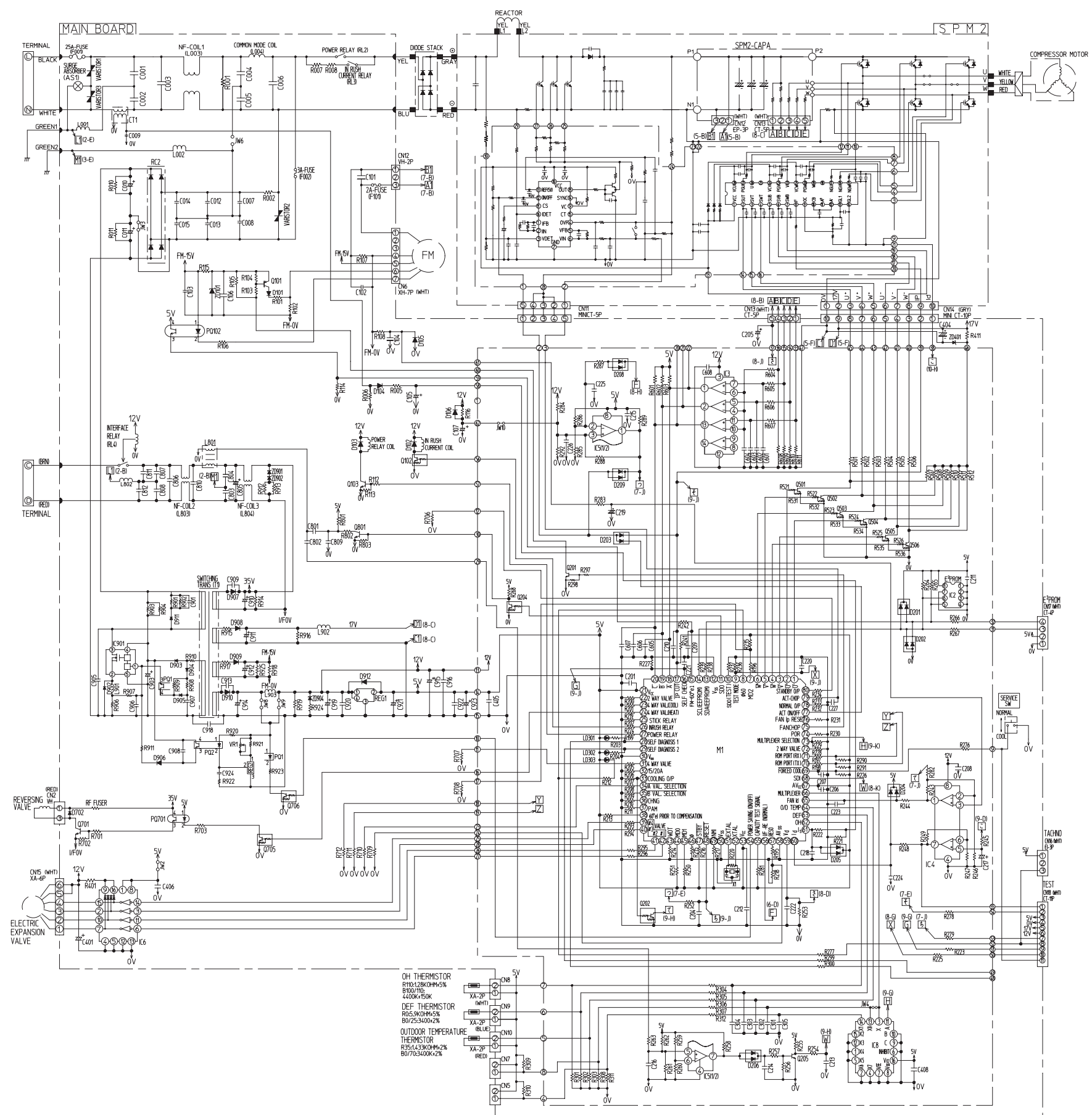

MOUNTING BOARD
 A: AXIAL
 R: RADIAL (R1, R2)
 P: RADIAL (7.5MM PITCH)
 H: MANUAL INSERT

IC
 C: CERAMIC
 F: FILM
 D: ELECTROLYTIC

BOARD
 HIC: HYBRID IC
 M: MAIN BOARD

COMPONENT TYPE
 C: CERAMIC
 F: FILM
 D: ELECTROLYTIC

RESISTORS

MARK	RATING (R)	(%)(W)	MOUNTING	REMARK
R001	470K	5% 1/2 A	M	
R002	2.2K	5% 1/2 A	M	
R003	1.69K	1% 1/2 A	M	
R004	100	5% 1/2 A	M	
R005	100	5% 1/2 A	M	
R006	100	5% 1/2 A	M	
R007	100	5% 1/2 A	M	
R008	100	5% 1/2 A	M	
R009	470K	5% 1/2 A	M	
R010	470K	5% 1/2 A	M	
R011	470K	5% 1/2 A	M	

RESISTORS

MARK	RATING (R)	(%)(W)	MOUNTING	REMARK
R101	3.6K	1% 1/2 A	M	
R102	3K	1% 1/2 A	M	
R103	3K	1% 1/2 A	M	
R104	3.9K	5% 1/2 A	M	
R105	7.5K	5% 1/2 A	M	
R106	2.2K	5% 1/2 A	M	
R107	1	1% 1/2 A	M	
R108	510	5% 1/2 A	M	
R109	10K	5% 1/2 A	M	
R110	7.5K	5% 1/2 A	M	
R111	10K	5% 1/2 A	M	
R112	10K	5% 1/2 A	M	
R113	10K	5% 1/2 A	M	
R114	10K	5% 1/2 A	M	
R115	JUMPER			
R116	JUMPER			

RESISTORS

MARK	RATING (R)	(%)(W)	MOUNTING	REMARK
R195	1K	5% 1/2 A	M	
R196	1K	5% 1/2 A	M	
R197	1K	5% 1/2 A	M	
R198	1K	5% 1/2 A	M	
R199	1K	5% 1/2 A	M	
R200	10K	5% 1/2 A	M	
R201	10K	5% 1/2 A	M	
R202	10K	5% 1/2 A	M	
R203	390	5% 1/2 A	M	
R204	390	5% 1/2 A	M	
R205	10K	5% 1/2 A	M	
R206	10K	5% 1/2 A	M	
R207	10K	5% 1/2 A	M	
R208	10K	5% 1/2 A	M	
R209	10K	5% 1/2 A	M	
R210	10K	5% 1/2 A	M	
R211	10K	5% 1/2 A	M	
R212	390	5% 1/2 A	M	
R213	10K	5% 1/2 A	M	
R214	10K	5% 1/2 A	M	
R215	10K	5% 1/2 A	M	
R216	10K	5% 1/2 A	M	
R217	10K	5% 1/2 A	M	
R218	10K	5% 1/2 A	M	
R219	10K	5% 1/2 A	M	
R220	10K	5% 1/2 A	M	
R221	10K	5% 1/2 A	M	
R222	10K	5% 1/2 A	M	
R223	10K	5% 1/2 A	M	
R224	10K	5% 1/2 A	M	
R225	10K	5% 1/2 A	M	
R226	10K	5% 1/2 A	M	
R227	10K	5% 1/2 A	M	
R228	10K	5% 1/2 A	M	
R229	10K	5% 1/2 A	M	
R230	10K	5% 1/2 A	M	
R231	10K	5% 1/2 A	M	
R232	10K	5% 1/2 A	M	
R233	10K	5% 1/2 A	M	
R234	10K	5% 1/2 A	M	
R235	10K	5% 1/2 A	M	
R236	10K	5% 1/2 A	M	
R237	10K	5% 1/2 A	M	
R238	10K	5% 1/2 A	M	
R239	10K	5% 1/2 A	M	

RESISTORS

MARK	RATING (R)	(%)(W)	MOUNTING	REMARK
R601	2K	5% 1/2 A	M	
R602	2K	5% 1/2 A	M	
R603	2K	5% 1/2 A	M	
R604	100	5% 1/2 A	M	
R605	100	5% 1/2 A	M	
R606	100	5% 1/2 A	M	
R607	100	5% 1/2 A	M	
R608	4.02K	1% 1/2 A	M	
R609	4.02K	1% 1/2 A	M	
R610	4.02K	1% 1/2 A	M	
R611	4.02K	1% 1/2 A	M	
R701	7.5K	5% 1/2 A	M	
R702	10K	5% 1/2 A	M	
R703	470	5% 1/2 A	M	
R704	10K	5% 1/2 A	M	
R705	10K	5% 1/2 A	M	
R706	10K	5% 1/2 A	M	
R707	10K	5% 1/2 A	M	
R708	10K	5% 1/2 A	M	
R709	10K	5% 1/2 A	M	
R710	10K	5% 1/2 A	M	

RESISTORS

MARK	RATING (R)	(%)(W)	MOUNTING	REMARK
R801	39	5% 1/2 A	M	
R802	39	5% 1/2 A	M	
R803	3K	5% 1/2 A	M	
R901	200K	5% 1/2 A	M	
R902	200K	5% 1/2 A	M	
R903	820K	5% 1/2 A	M	
R904	820K	5% 1/2 A	M	
R905	0.39	5% 1/2 A	M	
R906	680	5% 1/2 A	M	
R907	2.7K	5% 1/2 A	M	
R908	2.7K	5% 1/2 A	M	
R909	2.7K	5% 1/2 A	M	
R910	6.2	5% 1/2 A	M	
R911	4.3K	5% 1/2 A	M	
R912	270	5% 1/2 A	M	
R913	47K	5% 1/2 A	M	
R914	47K	5% 1/2 A	M	
R915	JUMPER			
R916	15K	5% 1/2 A	M	
R917	3.3	5% 1/2 A	M	
R918	10K	5% 1/2 A	M	
R919	3K	5% 1/2 A	M	
R920	680	5% 1/2 A	M	
R921	JUMPER			
R922	JUMPER			
R923	10K	5% 1/2 A	M	
R924	10K	5% 1/2 A	M	
R925	10K	5% 1/2 A	M	

RESISTORS

MARK	RATING (R)	(%)(W)	MOUNTING	REMARK
R276	100	5% 1/2 A	M	
R277	100	5% 1/2 A	M	
R278	100	5% 1/2 A	M	
R279	100	5% 1/2 A	M	
R281	10K	5% 1/2 A	M	
R282	10K	5% 1/2 A	M	
R283	10K	5% 1/2 A	M	
R284	10K	5% 1/2 A	M	
R285	4.7K	5% 1/2 A	M	
R286	5.1K	5% 1/2 A	M	
R287	10K	5% 1/2 A	M	
R288	5.1K	5% 1/2 A	M	
R289	5.1K	5% 1/2 A	M	
R290	10K	5% 1/2 A	M	
R291	10K	5% 1/2 A	M	
R292	10K	5% 1/2 A	M	
R293	100	5% 1/2 A	M	
R294	100	5% 1/2 A	M	
R295	100	5% 1/2 A	M	
R296	100	5% 1/2 A	M	
R297	100	5% 1/2 A	M	
R298	5.1K	5% 1/2 A	M	
R299	100	5% 1/2 A	M	

RESISTORS

MARK	RATING (R)	(%)(W)	MOUNTING	REMARK
R300	100	5% 1/2 A	M	
R301	3.74K	1% 1/2 A	M	
R302	3.01K	1% 1/2 A	M	
R303	3.01K	1% 1/2 A	M	
R304	100	5% 1/2 A	M	
R305	100	5% 1/2 A	M	
R306	100	5% 1/2 A	M	
R307	100	5% 1/2 A	M	

RESISTORS

MARK	RATING (R)	(%)(W)	MOUNTING	REMARK
R6E1	P005R008		H	M
R6E2	SE02N		H	M
IC2	SZ4C02BF-1TB		S	HIC
IC3	NM2904M-TET		S	HIC
IC4	NM2904M-TET		S	HIC
IC5	NM2903V-TET		S	HIC
IC6	M5467P		H	M
IC8	M5467P		H	M
M1	AX-8N00		O	HIC

RESISTORS

MARK	RATING (R)	(%)(W)	MOUNTING	REMARK
R308	100	5% 1/2 A	M	
R309	100	5% 1/2 A	M	
R310	100	5% 1/2 A	M	
R311	100	5% 1/2 A	M	
R312	100	5% 1/2 A	M	
R313	100	5% 1/2 A	M	
R314	100	5% 1/2 A	M	
R315	100	5% 1/2 A	M	
R316	100	5% 1/2 A	M	
R317	100	5% 1/2 A	M	
R318	100	5% 1/2 A	M	
R319	100	5% 1/2 A	M	
R320	100	5% 1/2 A	M	
R321	100	5% 1/2 A	M	
R322	100	5% 1/2 A	M	
R323	100	5% 1/2 A	M	
R324	100	5% 1/2 A	M	
R325	100	5% 1/2 A	M	

RESISTORS

MARK	RATING (R)	(%)(W)	MOUNTING	REMARK
R326	100	5% 1/2 A	M	
R327	100	5% 1/2 A	M	
R328	100	5% 1/2 A	M	
R329	100	5% 1/2 A	M	
R330	100	5% 1/2 A	M	
R331	100	5% 1/2 A	M	
R332	100	5% 1/2 A	M	
R333	100	5% 1/2 A	M	
R334	100	5% 1/2 A	M	
R335	100	5% 1/2 A	M	
R336	100	5% 1/2 A	M	
R337	100	5% 1/2 A	M	
R338	100	5% 1/2 A	M	
R339	100	5% 1/2 A	M	
R340	100	5% 1/2 A	M	
R341	100	5% 1/2 A	M	
R342	100	5% 1/2 A	M	
R343	100	5% 1/2 A	M	
R344	100	5% 1/2 A	M	
R345	100	5% 1/2 A	M	
R346	100	5% 1/2 A	M	
R347	100	5% 1/2 A	M	
R348	100	5% 1/2 A	M	
R349	100	5% 1/2 A	M	
R350	100	5% 1/2 A	M	

RESISTORS

MARK	RATING (R)	(%)(W)	MOUNTING	REMARK
R351	100	5% 1/2 A	M	
R352	100	5% 1/2 A	M	
R353	100	5% 1/2 A	M	
R354	100	5% 1/2 A	M	
R355	100	5% 1/2 A	M	
R356	100	5% 1/2 A	M	
R357	100	5% 1/2 A	M	
R358	100	5% 1/2 A	M	
R359	100	5% 1/2 A	M	
R360	100	5% 1/2 A	M	
R361	100	5% 1/2 A	M	
R362	100	5% 1/2 A	M	
R363	100	5% 1/2 A	M	
R364	100	5% 1/2 A	M	
R365	100	5% 1/2 A	M	
R366	100	5% 1/2 A	M	
R367	100	5% 1/2 A	M	
R368	100	5% 1/2 A	M	
R369	100	5% 1/2 A	M	
R370	100	5% 1/2 A	M	

RESISTORS

MARK	RATING (R)	(%)(W)	MOUNTING	REMARK
R371	100	5% 1/2 A	M	
R372	100	5% 1/2 A	M	
R373	100	5% 1/2 A	M	
R374	100	5% 1/2 A	M	
R375	100	5% 1/2 A	M	
R376	100	5% 1/2 A	M	
R377	100	5% 1/2 A	M	
R378	100	5% 1/2 A	M	
R379	100	5% 1/2 A	M	
R380	100	5% 1/2 A	M	
R381	100	5% 1/2 A	M	
R382	100	5% 1/2 A	M	
R383	100	5% 1/2 A	M	
R384	100	5% 1/2 A	M	
R385	100	5% 1/2 A	M	
R386	100	5% 1/2 A	M	
R387	100	5% 1/2 A	M	
R388	100	5% 1/2 A	M	
R389	100	5% 1/2 A	M	
R390	100	5% 1/2 A	M	

RESISTORS

MARK	RATING (R)	(%)(W)	MOUNTING	REMARK
R391	100	5% 1/2 A	M	
R392	100	5% 1/2 A	M	
R393	100	5% 1/2 A	M	
R394	100	5% 1/2 A	M	
R395	100	5% 1/2 A	M	
R396	100	5% 1/2 A	M	
R397	100	5% 1/2 A	M	
R398	10			

BLOCK DIAGRAM

MODEL RAF-25NH4 / RAC-25NH4
RAF-50NH4 / RAC-50NH4

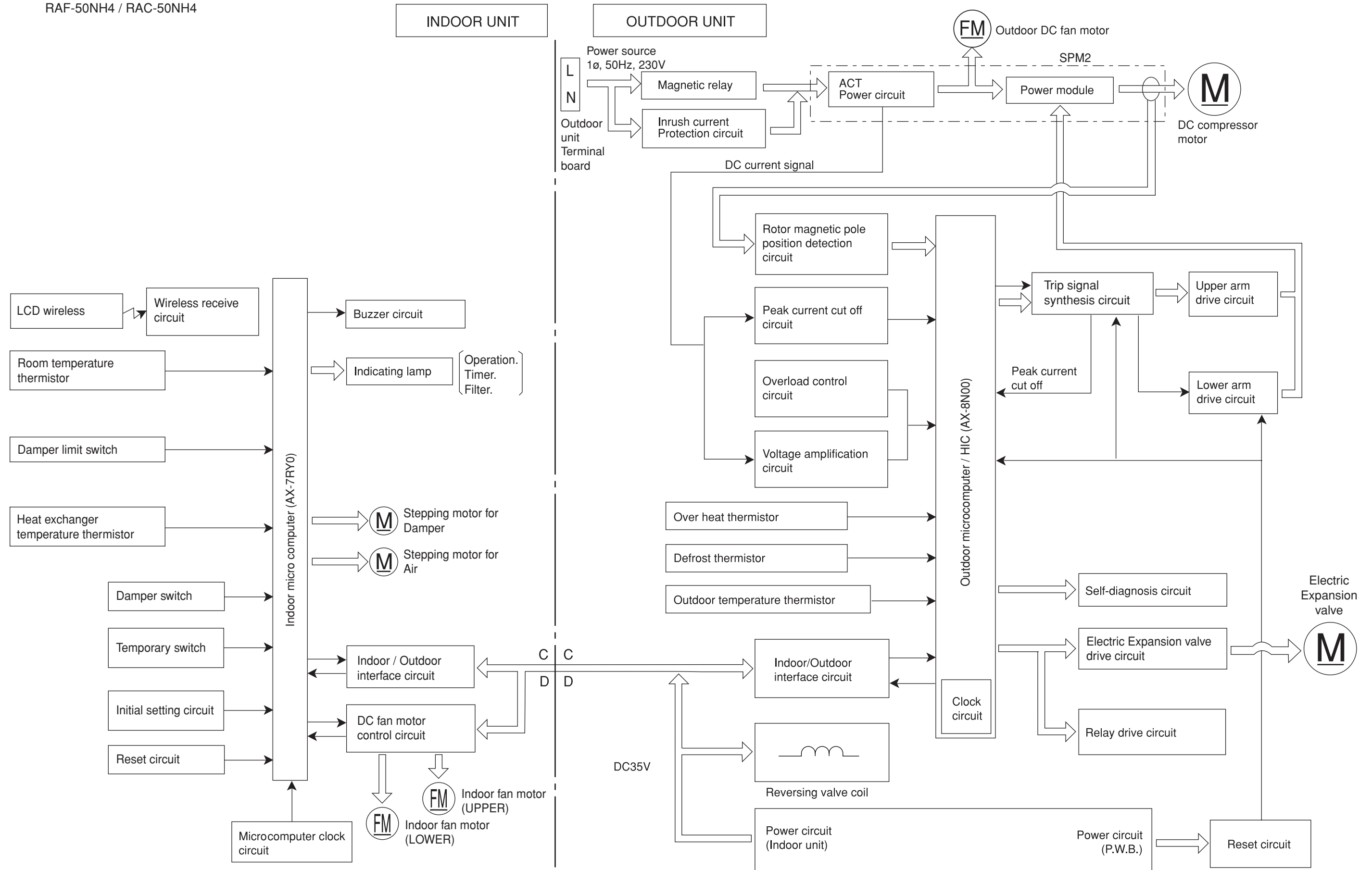

BASIC MODE

MODEL RAF-25NH4, RAF-50NH4

Operation mode		Fan	Cooling	Dehumidifying	Heating	Auto
Basic operation of start/stop switch						
Timer functions	Off-timer					
	On-timer					
Fan speed mode (indoor fan)	Auto	<p>Changes from "Hi" to "Med" depending on room temperature.</p>	<p>Set to "ultra-Hi" when the compressor runs at maximum speed, and to "Hi" in other modes.</p>	<p>Set to "ultra-Lo", "Lo", "Med", "Hi", "ultra-Hi" or "stop" depending on the room temperature, time and heat exchange temperature. Set to "stop" if the room temperature is 18°C in the "ultra-Lo" mode other than during preheating (cooling is recovered at 18.33°C).</p> <p>When the compressor is running at maximum speed during hot dash or when recovered from defrosting.</p>	<p>Operating mode is judged by room temperature and outdoor temperature.</p> <p>(1) Judging by outdoor temperature</p> <ul style="list-style-type: none"> Operating mode is judged by outdoor temperature. Only when the mode is not restricted by this judgment, the judgment by room temperature in the next paragraph will be performed. <ul style="list-style-type: none"> (a) Outdoor temperature $\geq 27^\circ\text{C}$: Restricted to cooling (b) Outdoor temperature $\leq 16^\circ\text{C}$: Restricted to heating (2) Judging by room temperature <ul style="list-style-type: none"> Operating mode at start up is judge (Initial judgement) <ul style="list-style-type: none"> (a) Conditions for judgment (any of the followings) <ul style="list-style-type: none"> When auto operation is started after 1 hour has elapsed since the operation was stopped. When auto operation is started after the previous manual mode operation. When the operating: mode is switched to auto while operating at manual mode. (b) Judging method <ul style="list-style-type: none"> Room temperature $\geq 22^\circ\text{C} \pm 3^\circ\text{C}$: Cooling Room temperature $< 22^\circ\text{C} \pm 3^\circ\text{C}$: Heating <p>$\pm 3^\circ\text{C}$ is the fine adjustment value from the remote controller.</p> 	
	Hi	Operates at "Hi" regardless of the room temperature.	Set to "ultra-Hi" when the compressor runs at maximum speed, and to "Hi" in other modes.	Set to "ultra-Lo", "Lo", "Med", "Hi", "ultra-Hi" or "stop" depending on the room temperature, and time. Set to "stop" if the room temperature is 18°C in the "ultra-Lo" mode other than during preheating (cooling is recovered at 18.33°C). Set to "ultra-Hi" when the compressor is running at maximum speed during hot dash or when recovered from defrosting.	<p>Set to "ultra-Lo", "Lo", "Med", "Hi", "ultra-Hi" or "stop" depending on the room temperature, and time. Set to "stop" if the room temperature is 18°C in the "ultra-Lo" mode other than during preheating (cooling is recovered at 18.33°C). The fan speed is controlled by the heat exchanger temperature; the overload control is executed as in the following diagram:</p>	<p>Judging operating mode change during operation (Continuous judgment)</p> <p>(a) Conditions for judgment (any of the followings)</p> <ul style="list-style-type: none"> The mode is reviewed at every interval time. When auto operation is started again before 1 hour has elapsed since the operation was stopped. <p>(b) Judging method</p> <ul style="list-style-type: none"> Judge by setting the hysteresis on the final preset temperature. The final preset temperature is the actually targeted preset temperature which is the sum of the basic preset temperature and each type of shift value (e.g. $\pm 3^\circ\text{C}$ by remote controller, preset temperature correction value, powerful shift value, etc.). <p>[Currently cooling]</p> <ul style="list-style-type: none"> Room temperature \leq Final preset temperature -2°C Change to heating Room temperature $>$ Final preset temperature -2°C Continue cooling <p>[Currently heating]</p> <ul style="list-style-type: none"> Room temperature \geq Final preset temperature $+3^\circ\text{C}$ Change to cooling Room temperature $<$ Final preset temperature $+3^\circ\text{C}$ Continue heating
	Med	Operates at "Med" regardless of the room temperature.	Same as at left.	Set to "ultra-Lo", "Lo", "Med" or "stop" depending on the room temperature and time. Set to "stop" if the room temperature is 18°C in the "ultra-Lo" mode other than during preheating (cooling is recovered at 18.33°C).		
	Lo	Operates at "Lo" regardless of the room temperature.	Same as at left.	Set to "Lo" in modes other than when the compressor stops.	Set to "ultra-Lo", "Lo", or "stop" depending on the room temperature and time. Set to "stop" if the room temperature is 18°C in the "ultra-Lo" mode other than during preheating (cooling is recovered at 18.33°C).	
Basic operation of temperature controller	Performs only fan operation at the set speed regardless of the room temperature.	See page 33.	See page 36.	See page 38.		
Sleep operation (with sleep button ON)	<ul style="list-style-type: none"> Enters sleep operation after set as on the left. Action during sleep operation Lo (sleep) operation 	<ul style="list-style-type: none"> Same as at left. See page 34. 	<ul style="list-style-type: none"> Same as at left See page 37. 	<ul style="list-style-type: none"> Same as at left See page 41. 	<ul style="list-style-type: none"> Same as at left. Performs the sleep operation of each operation mode. 	

Notes:

- The speed set of rotation for the fan motor in each operation mode are as shown in Table 1.
- The set room temperatures in the diagram include the shift values in Table 2.
- See "Damper control theory" for damper control and upper / lower fan operations.

Basic Cooling Operation

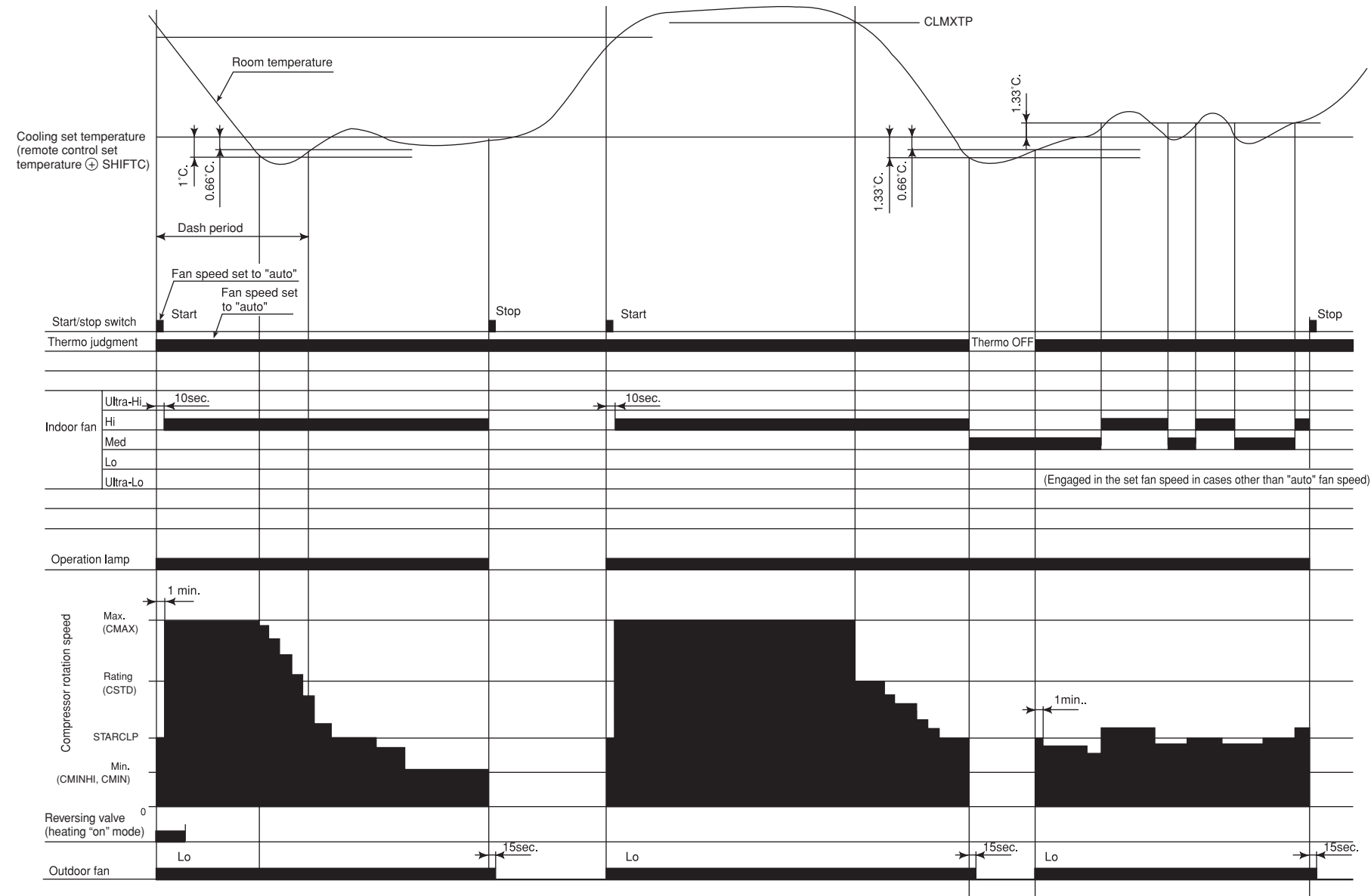

Notes:

- (1) Cool dash is started when the operation is started at fan speed "AUTO" or "HI" or when the fan speed is changed to "AUTO" or "HI" during cooling operation, and when the compressor speed (P item) reaches CMAX or higher (See Table 1).
- (2) The maximum compressor speed period during cool dash is finished ① when 25 minutes have elapsed after cool dash was started ② when the room temperature reaches the cooling set temperature -1°C (including cooling shift) and then becomes lower than the preset temperature by 0.66°C after the steady speed period, ③ when thermo is OFF.
(if cool dash finished in the above ①, the compressor does not go through the steady speed period but it starts fuzzy control.)
- (3) The thermo OFF temperature during cool dash is cooling set temperature (including cooling shift) -3°C. After thermo OFF, cool dash is finished and fuzzy control starts.
- (4) The compressor minimum ON time and minimum OFF time is 3 minutes.
- (5) The time limit for which the maximum compressor speed (CMAX) during normal cooling can be maintained is less than 60 minutes when the room temperature is less than CLMXTP: it is not provided when the room temperature is CLMXTP or more.
- (6) If the fan speed is set to "Med" by remote control, the maximum compressor speed is CJKMAX.
- (7) If the fan speed is set to "Lo" by remote control, the maximum compressor speed is CBEMAX.
- (8) If the fan speed is set to "Hi" by remote control and both the room temperature and outside temperature (data from the outdoor unit) satisfy the condensation condition in Table 2, the maximum compressor speed is CKYMAX.
- (9) While the cooling thermo is OFF, the indoor fan speed is maintained at the preset fan speed.
- (10) See "Damper control theory" for damper control and upper / lower fan operations.

Table 1 The temperature differences and compressor speed

① Model : RAF-25NH4

Compressor speed (P item)	Room temperature-setting temperature (including shift)
1900min ⁻¹	1.00°C
2100min ⁻¹	1.33°C
2600min ⁻¹	1.66°C
3100min ⁻¹	2.00°C
3600min ⁻¹	2.33°C

② Model : RAF-50NH4

Compressor speed (P item)	Room temperature-setting temperature (including shift)
2400min ⁻¹	1.33°C
2900min ⁻¹	1.66°C
3400min ⁻¹	2.00°C
3900min ⁻¹	2.33°C
4400min ⁻¹	2.66°C
4900min ⁻¹	3.00°C
5400min ⁻¹	3.33°C
5900min ⁻¹	3.66°C

Table 2 Condensation Condition Criterion Value

	Item	Temperature
Room temperature	Condensation condition (engaged)	30°C
	Condensation condition (released)	32°C
Outdoor temperature	Condensation condition (engaged)	32°C
	Condensation condition (released)	34°C

Cooling Sleep Operation

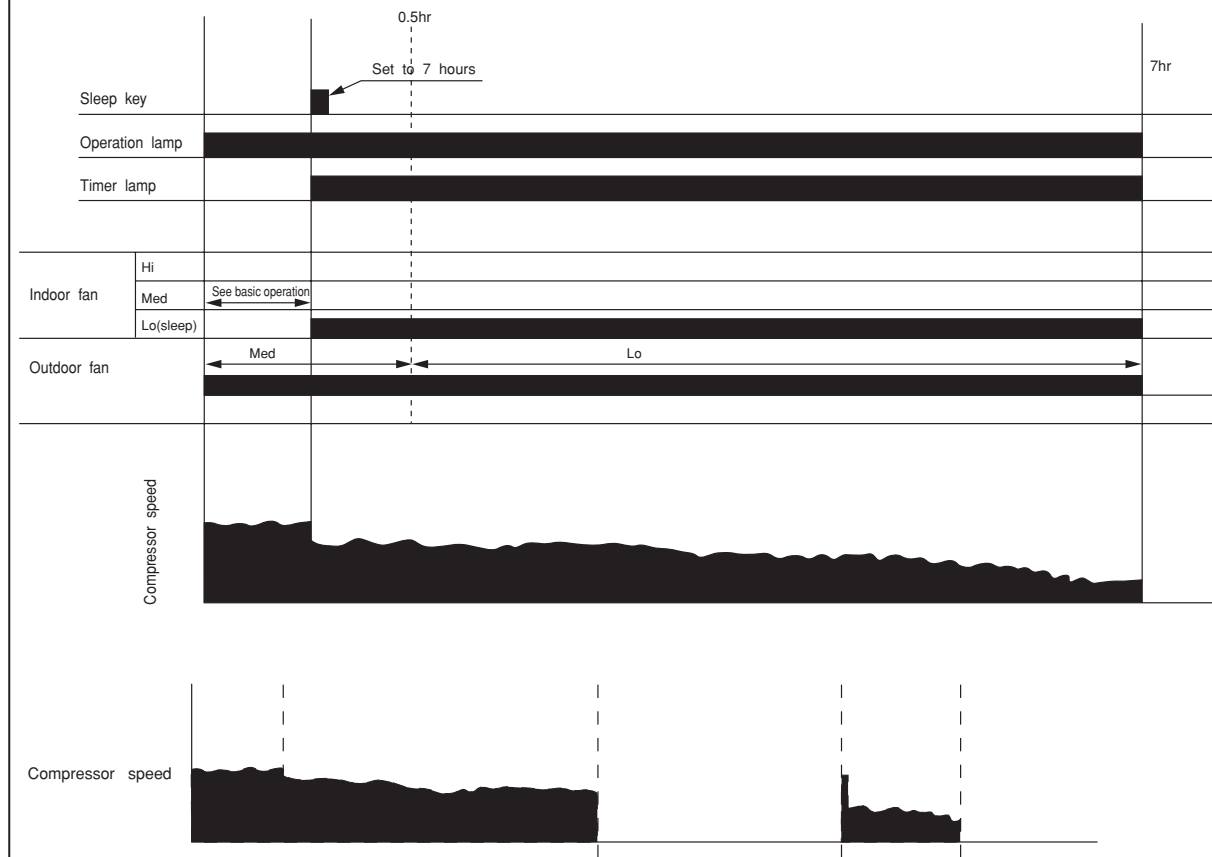

Notes:

- (1) The sleep operation starts when the sleep key is pressed.
- (2) When the sleep key is set, the maximum compressor speed is limited to CBEMAX, and the indoor fan is set to "sleep, silent" (FCSOY).
- (3) If the operation mode is changed during sleep operation, the set temperature is cleared, and shift starts from the point when switching is made.
- (4) The indoor fan speed does not change even when the fan speed mode is changed.
- (5) When operation is stopped during sleep operation, the set temperature when stopped, as well as the time, continue to be counted.
- (6) If the set time is changed during sleep operation, all data including set temperature, time, etc. is cleared and restarted.
- (7) If sleep operation is canceled by the cancel key or sleep key, all data is cleared.
- (8) The indoor fan is stopped while the thermo is OFF during sleep operation.
- (9) There is no preset temperature shift due to time elapse.

Cooling Defrost

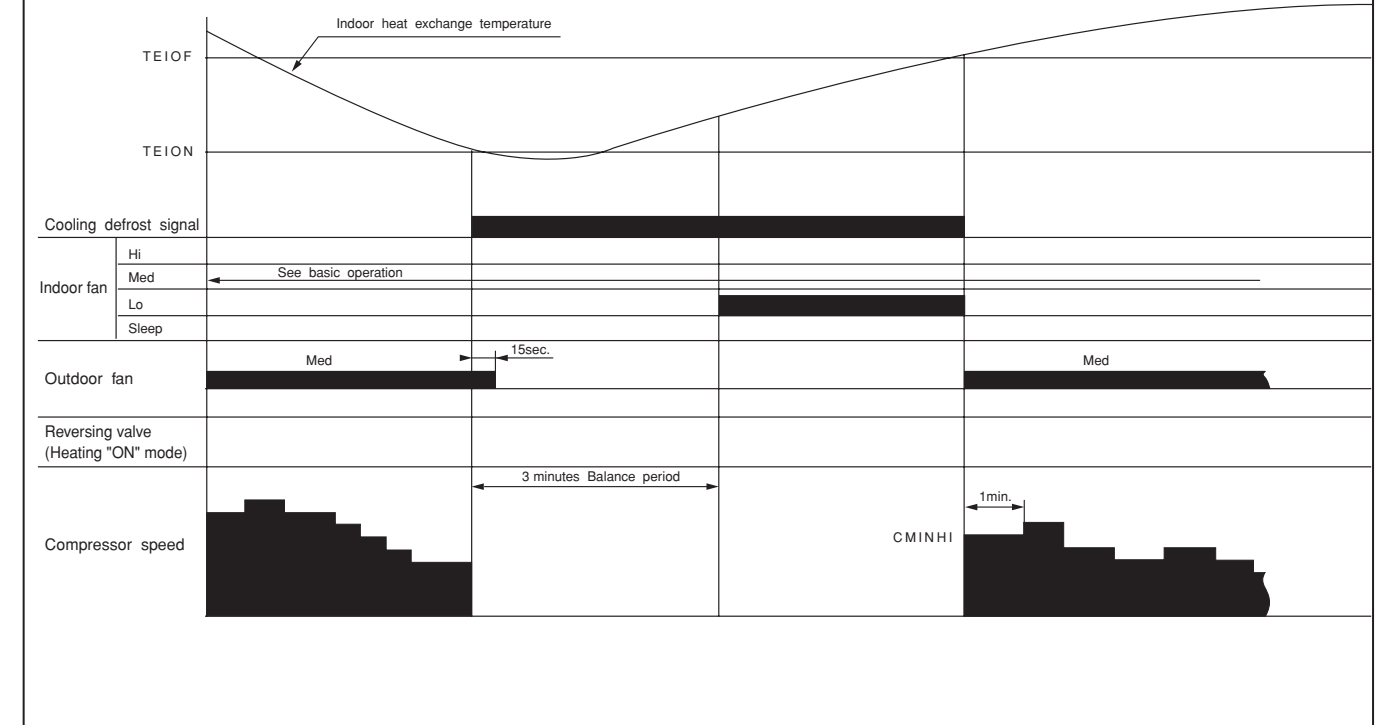

Dehumidifying

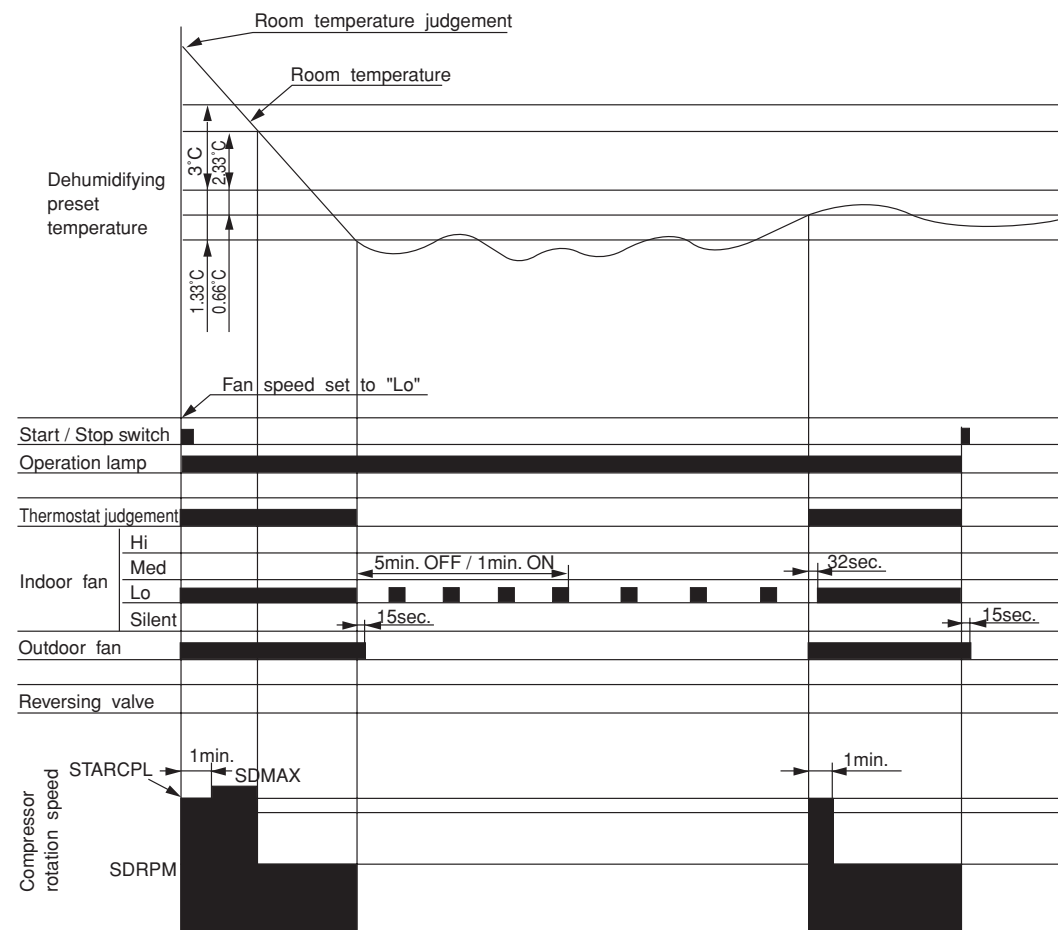

Notes:

- (1) The indoor fan is operated in the "Lo" or "Silent" mode, OFF for 5 minutes and ON for 1 minute, repeatedly according to the humidity judgement when the thermostat is turned OFF.
- (2) When the operation is started by the thermostat turning ON, the start of the indoor fan is delayed 32 seconds after the start of compressor operation.
- (3) The compressor is operated forcedly for 3 minutes after operation is started.
- (4) The minimum ON time and OFF time of the compressor are 3 minutes.

Dehumidifying Sleep Operation

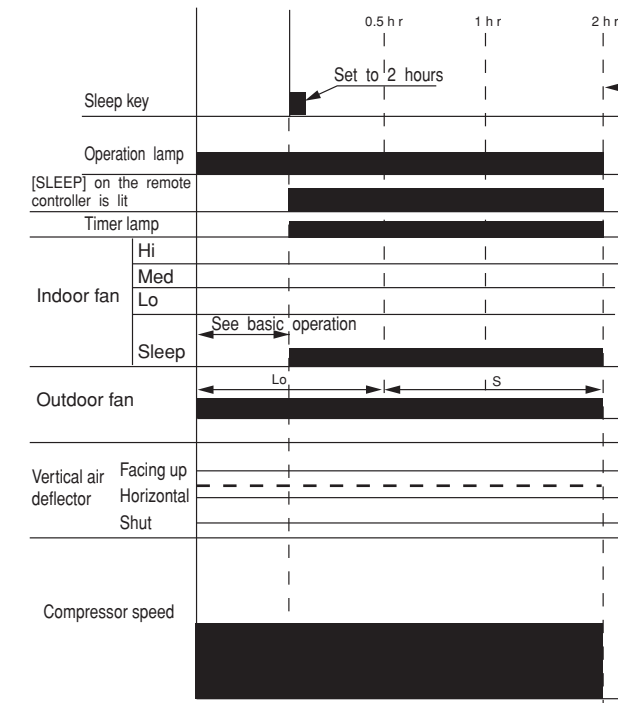

Notes:

- (1) The sleep operation starts when the sleep key is pressed.
- (2) When the sleep key is set, the indoor fan is set to "Sleep Silent" (FDOY).
- (3) If the operation mode is changed during sleep operation, the set temperature is cleared, and shift starts from the point when switching is made.
- (4) The indoor fan speed does not change even when the fan speed mode is changed.
- (5) When operation is stopped during sleep operation, the set temperature when stopped, as well as the time, continue to be counted.
- (6) If the set time is changed during sleep operation, all data including set temperature, time, etc. is cleared and restarted.
- (7) If sleep operation is canceled by the cancel key or sleep key, all data is cleared.
- (8) The indoor fan is stopped while the thermo is OFF during sleep operation.
- (9) There is no preset temperature shift due to time elapse.

Heating Basic Operation

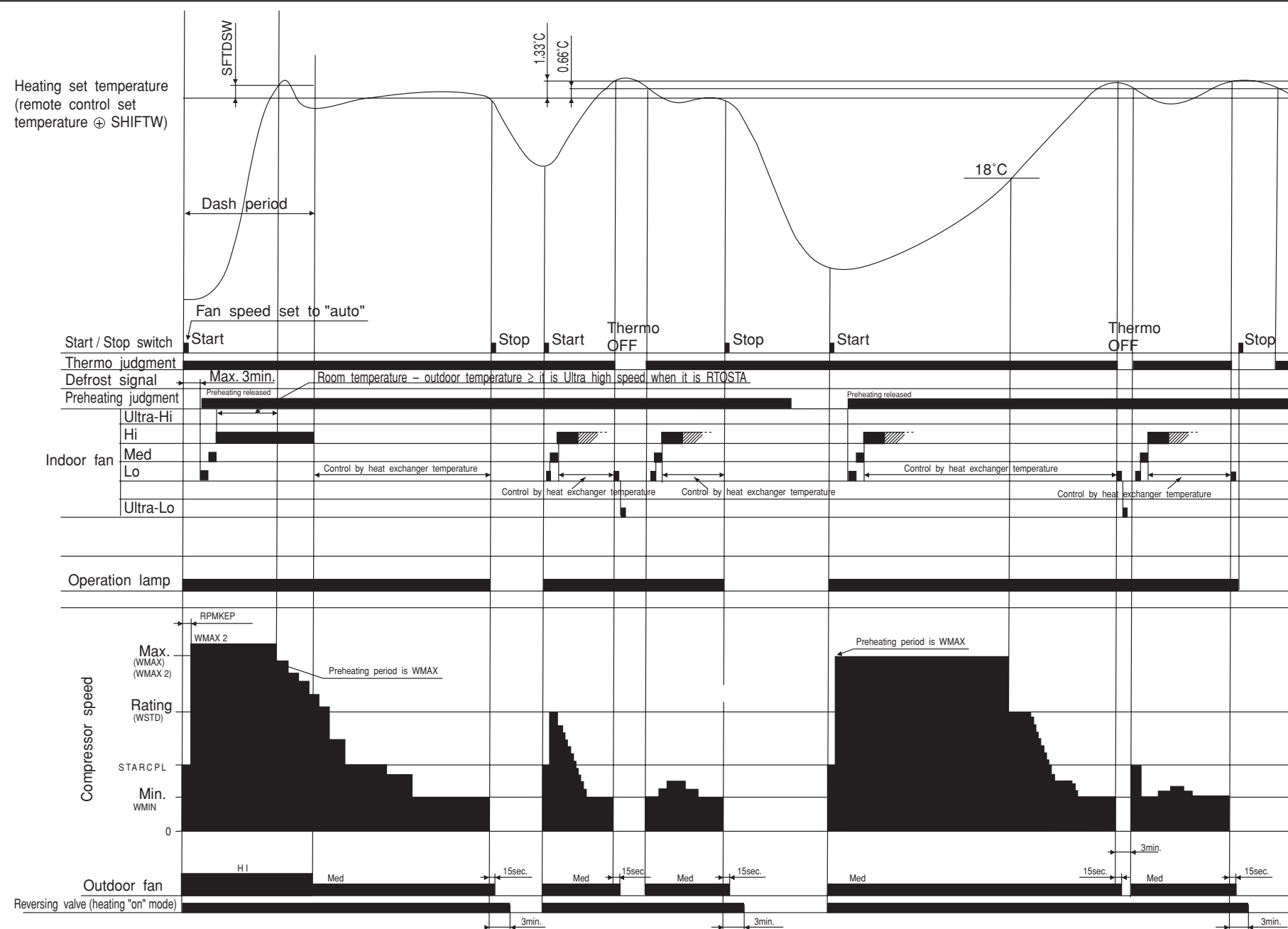

Notes:

- (1) Hot dash is engaged if the difference between the room temperature and set temperature is equal to that between the room temperature, at which the compressor reaches maximum speed, and set temperature (See Table 1), and the room and outdoor temperatures are less than 10°C; when the fan speed is "auto", operation is started at "Hi", or the fan speed is changed to "Hi" during heating.
- (2) The maximum compressor speed period during hot dash is finished (1) when the room temperature reaches the heating set temperature (including heating shift) plus SFTDSW or (2) when the thermo is off.
- (3) The thermo OFF temperature during hot dash is heating set temperature (including heating shift) plus 3°C. After thermo OFF, hot dash finishes, and FUZZY control start.
- (4) The compressor minimum ON time and minimum OFF time is 3 minutes.
- (5) The time limit for which the maximum compressor speed (WMAX) or (WMAX2) during normal heating (except for hot dash) can be maintained is less than 120 minutes when the room temperature is 18°C or more; it is not provided when the room temperature is less than 18°C and outdoor temperature is less than 2°C.
- (6) The operation indicator blinks every second during initial cycle operation, preheating, defrosting (including balance time after defrosting is finished), or auto fresh defrosting.
- (7) For preheating judgment, preheating starts if the heat exchange temperature is lower than YNEOF°C and is cancelled if the heat exchange temperature is YNEOF plus 0.33°C or higher at the start of operation using the START / STOP button.
- (8) During the operation at the fan speed of "Lo", the compressor speed is set to WBEMAX or below. It is restricted to WJKMAX or below when the fan speed is "Med".
- (9) If the outdoor temperature (data from outdoor unit) is 6°C or more, the maximum compressor speed is WSTD.
- (10) If the room temperature falls to less than 18°C in the "Ultra-Lo" mode, the indoor fan stops. When the room temperature is 18°C+0.33°C or more, the ultra-Lo operation restarts. However, the ultra-Lo operation during preheating or preheating after defrosting does not stop if the room temperature is less than 18°C.
- (11) WMAX2 is used as the maximum compressor speed during hot dash, when the outdoor temperature is less than -5°C.
- (12) With thermo OFF or in approximately 1 minute after operation is stopped using the remote controller, the fan operates in the "Ultra-Lo" mode. This operation is for discharging heat from the indoor unit.

Table 1 The temperature differences and compressor speed

① Model: RAF-25NH4

Compressor speed (P item)	Setting temperature (including shift) - Room temperature
1900min ⁻¹	1.00°C
2100min ⁻¹	1.33°C
2600min ⁻¹	1.66°C
3100min ⁻¹	2.00°C
3600min ⁻¹	2.33°C

② Model: RAF-50NH4

Compressor speed (P item)	Setting temperature (including shift) - Room temperature
2400min ⁻¹	1.33°C
2900min ⁻¹	1.66°C
3400min ⁻¹	2.00°C
3900min ⁻¹	2.33°C
4400min ⁻¹	2.66°C
4900min ⁻¹	3.00°C
5400min ⁻¹	3.33°C
5900min ⁻¹	3.66°C

Reversing Valve Defrosting

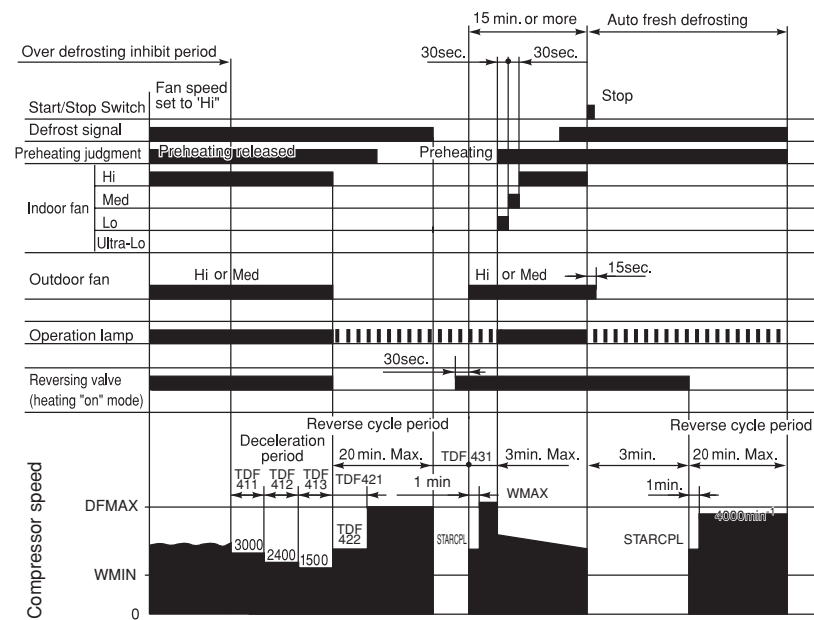

Notes:

- (1) The defrosting inhibit period is set as shown in the diagram below. When defrosting has finished once, the inhibit period is newly set, based on the outdoor temperature when the compressor was started. During this period, the defrost signal is not accepted.
- (2) If the difference between the room and outdoor temperatures is large when defrosting is finished, the maximum compressor speed (WMAX) or (WMAX2) can be continued for 120 minutes maximum.
- (3) The defrosting period is 20 minutes maximum.
- (4) When operation is stopped during defrosting, it is switched to auto refresh defrosting.
- (5) Auto refresh defrosting cannot be engaged within 15 minutes after operation is started or defrosting is finished.

Setting Defrosting Inhibit Period

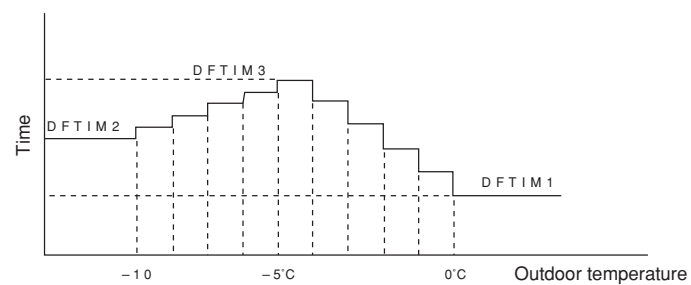

Notes:

- (1) The first inhibit time after operation start is set to DFTIM1.
- (2) From the second time onwards, the inhibit time is set according to the time required for defrosting.
Reverse cycle operation time \geq [DEFCOL] : DFTIM1 is set.
Reverse cycle operation time $<$ [DEFCOL] : The time corresponding to outdoor temperature is set.

Heating Sleep Operation

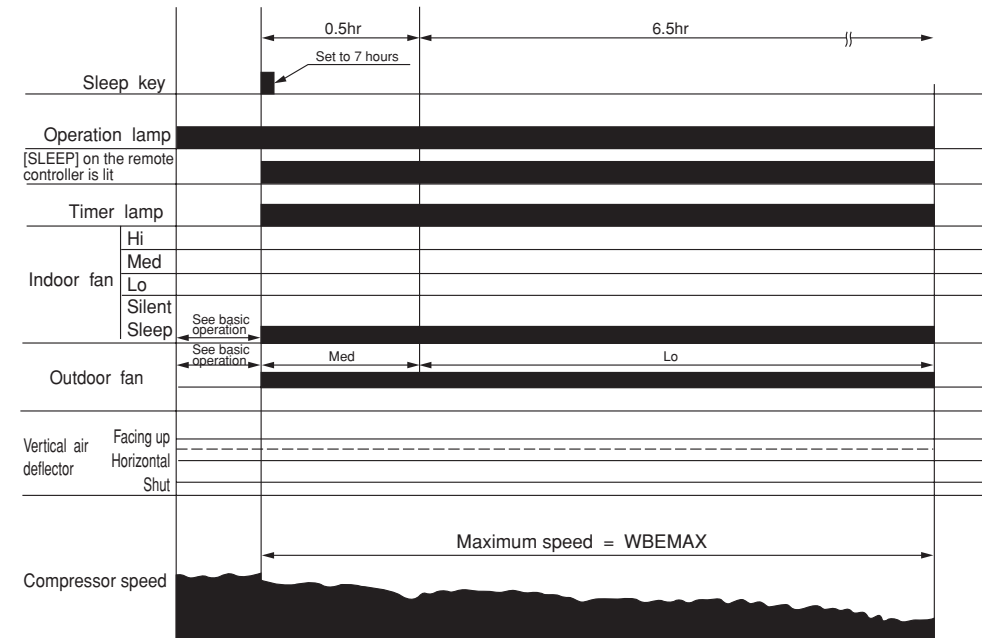

Notes:

- (1) The sleep operation starts when the sleep key is pressed.
- (2) When the sleep key is set, the maximum compressor speed is limited to WBEMAX, and the indoor fan is set to "Sleep Silent" (FWSOY).
- (3) If the operation mode is changed during sleep operation, the changed operation mode is set and sleep control starts.
- (4) The indoor fan speed does not change even when the fan speed mode is changed. (Lo)
- (5) When defrosting is to be set during sleep operation, defrosting is engaged and sleep operation is restored after defrosting.
- (6) When operation is stopped during sleep operation, the set temperature when stopped, as well as the time, continue to be counted.
- (7) If the set time is changed during sleep operation, all data including set temperature, time, etc. is cleared and restarted.
- (8) If sleep operation is cancelled by the cancel key or sleep key all data is cleared.
- (9) There is no preset temperature shift due to time elapse.

NOTE

1. Refer to the PWRITE-ZU data for the constants expressed by capital alphabet letters in the drawing.

REFRIGERATING CYCLE DIAGRAM

MODEL RAF-25NH4 / RAC-25NH4

COOLING, DEHUMIDIFYING, DEFROSTING

OUTDOOR UNIT

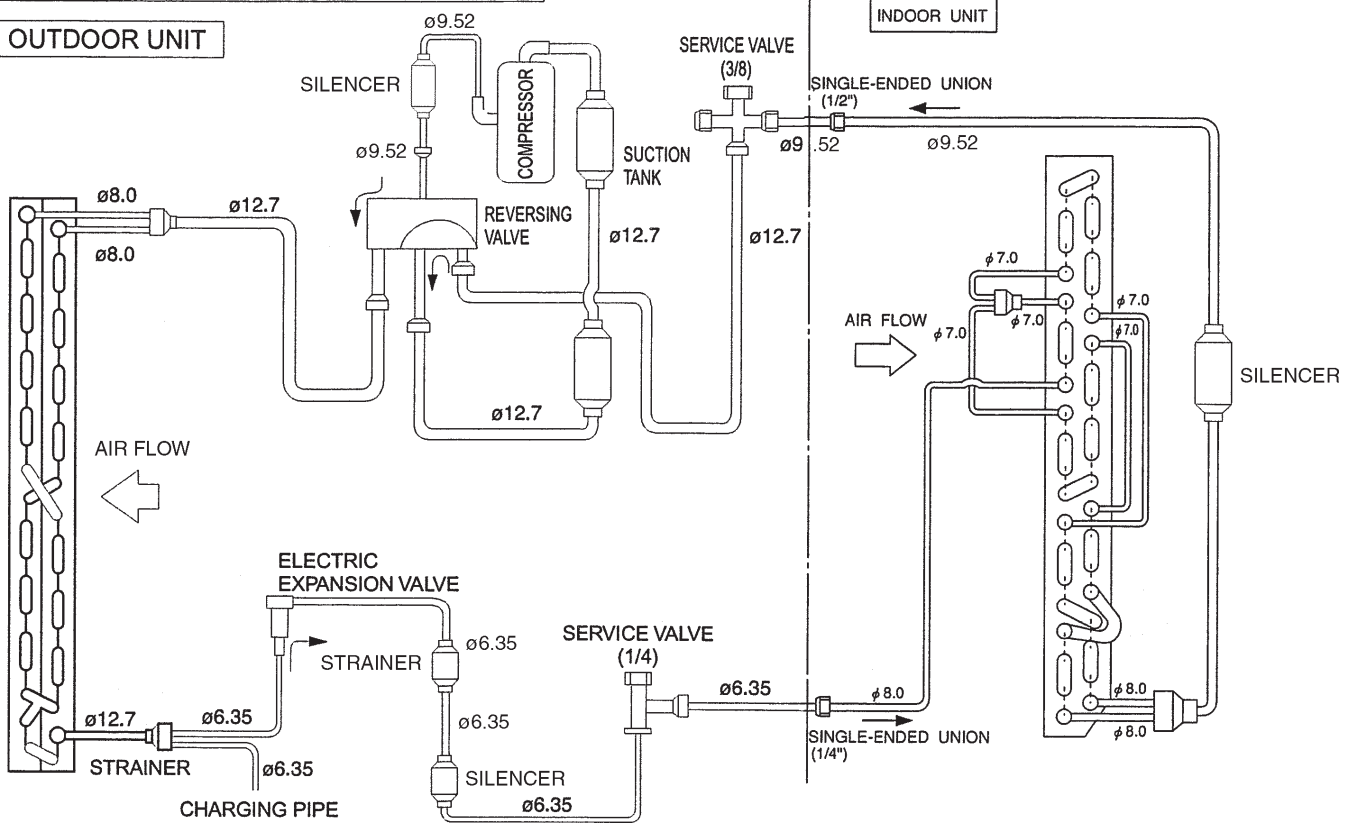

HEATING

OUTDOOR UNIT

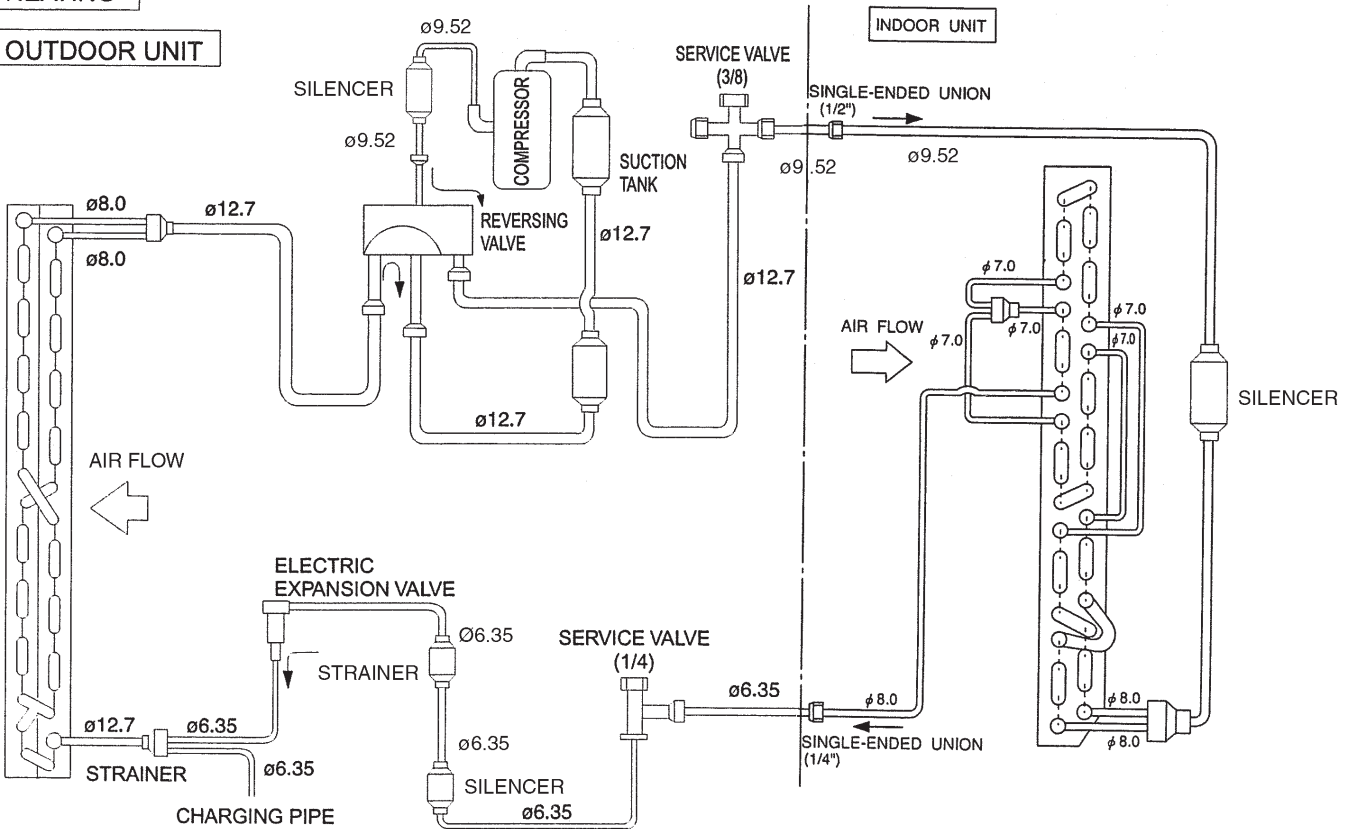

REFRIGERATING CYCLE DIAGRAM

MODEL RAF-50NH4 / RAC-50NH4

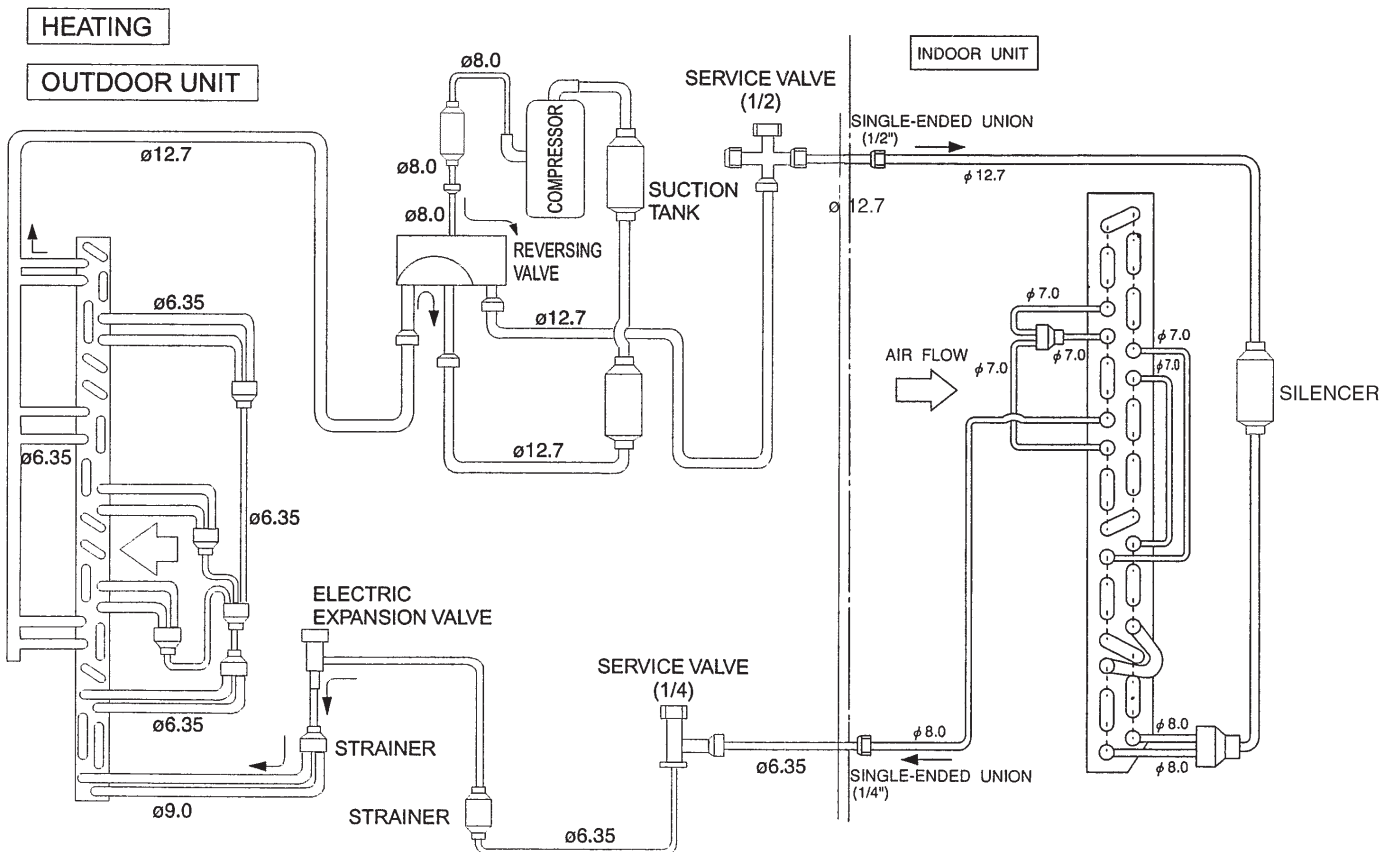
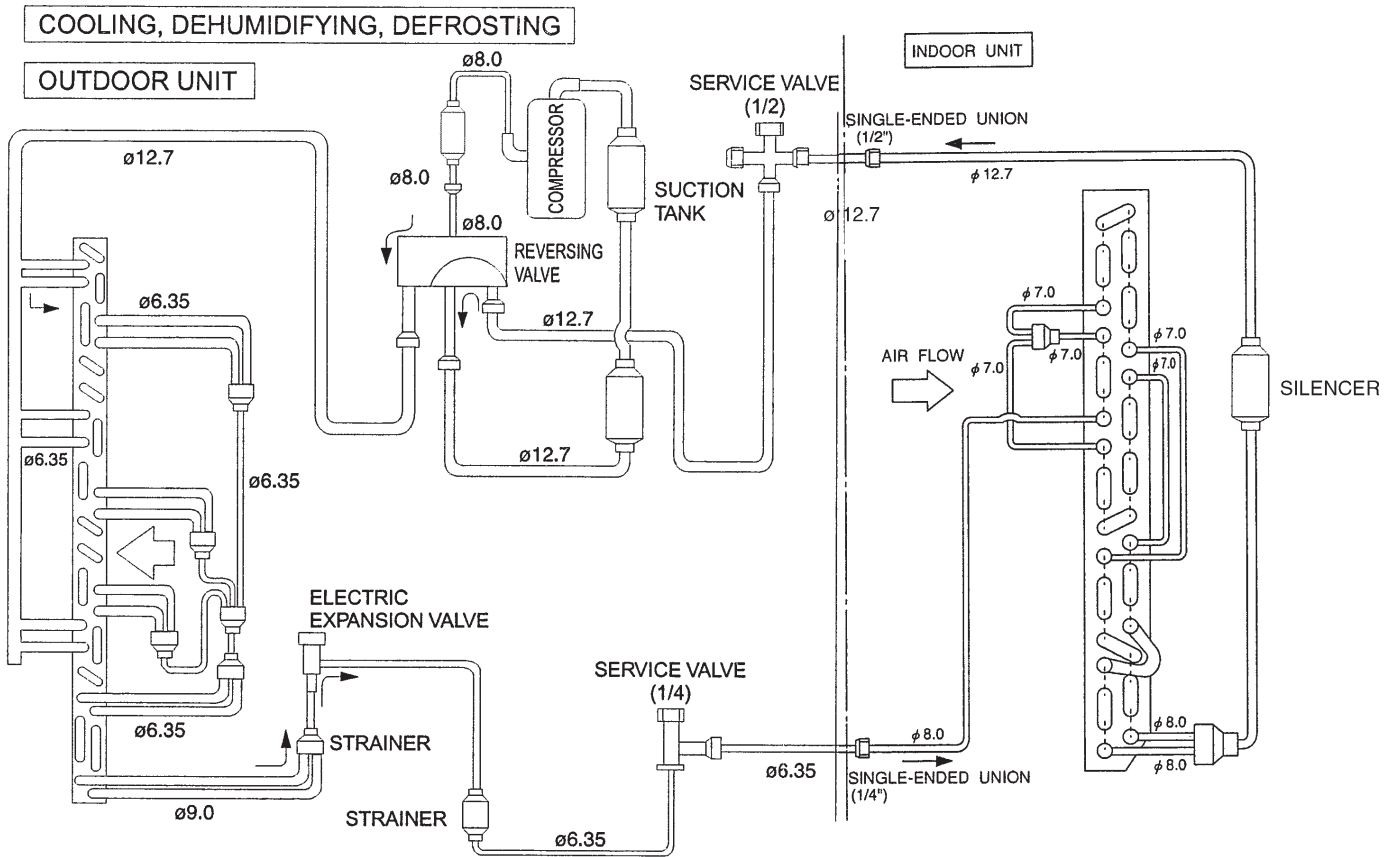

Damper control

1. Precondition

The damper has 2-directional output and realizes OPEN/CLOSE using a stepping motor.
Damper control functions only when the Air outlet SW is set to " ".

2. OPEN/CLOSE Operation

(1) OPEN operation

Start up the damper towards OPEN direction by overall angle width [DNPALD1]. When the start up completes, turn off the output.

(2) CLOSE operation

Start up the damper towards CLOSE direction by overall angle width [DNPALD1]+tightening angle [CNPPLS1]. When start up completes, turn off the output.

3. Initial Operation

Initial operation is performed only once when the main power is switched ON. The damper should be operated as follows due to its structure.

① Damper OPEN (Damper limit SW = OFF signal)

② Damper CLOSE (Damper limit SW = ON signal)

Its travel speed is pulse output speed [DNPPPS].

4. Monitor Function of Damper Limit SW

Monitoring of damper limit SW is inhibited during start up and for 2 seconds after starting up the damper. After which the damper limit SW will be monitored.

(1) Damper limit SW signal at the completion of initial operation is monitored. If the signal is OFF, it is judged as malfunction and the malfunction mode is entered immediately.

(2) Monitoring of damper limit SW signal is inhibited while the unit is stopped.

(3) Damper limit SW is always monitored while the unit is in operation. Right after the unit operation is started, however, malfunction judgment is not made and the damper performs the following operation.

When "ON" signal is detected (Normal signal): Start up towards CLOSE direction by tightening angle.

When "OFF" signal is detected (Abnormal signal): Start up towards CLOSE direction by overall angle width plus tightening angle.

(4) After performing the above operation, malfunction judgment will always be carried out. If abnormality is detected for 4 times consecutively within 30 minutes, the malfunction mode is entered at the moment the 4th abnormality is detected.

In the case where 3 or less abnormality are detected, retry operation is performed.

Abnormal OPEN location

If the signal is "ON", the damper is judged to be at CLOSE location (abnormal). The retry operation, which is the same as OPEN operation by overall angle width, will be performed.

Abnormal CLOSE location

If the signal is "OFF", the damper is judged to be at OPEN location (abnormal). The retry operation, which is the same as CLOSE operation by overall angle width + tightening angle, will be performed.

(5) Self diagnosis mode of the damper is indicated by "Timer lamp blinks for 8 times".

5. Damper operation by operating modes

The damper functions only during heating and cooling operation. It stays closed during other operating modes.

Heating mode

The damper is open during normal heating operation (except for 10 seconds after thermo resumes, during sleep operation and during nice temperature). It is closed during other types of operation.

The damper closes immediately if the damper changeover SW is set to "manual". When the damper is starting up, however, it closes only after open operation completed.

Main operation ON/OFF (with preheating)

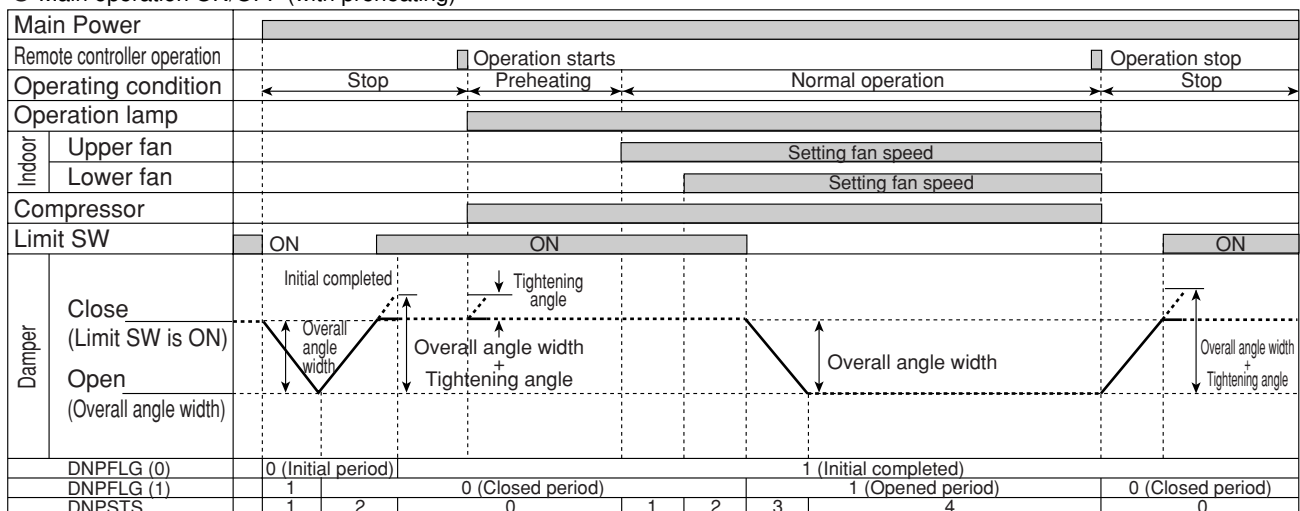

Note: Regardless of "ON" and "OFF" of the limit SW, the damper performs OPEN operation when the power is switched on.

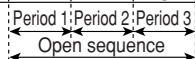

● Thermo intermittence

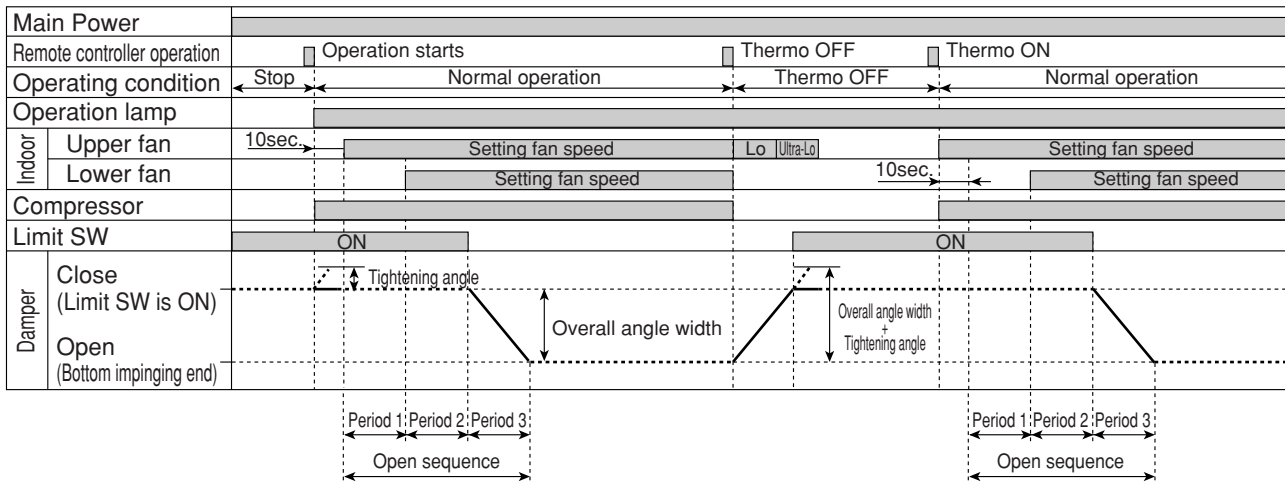

● Sleep Timer

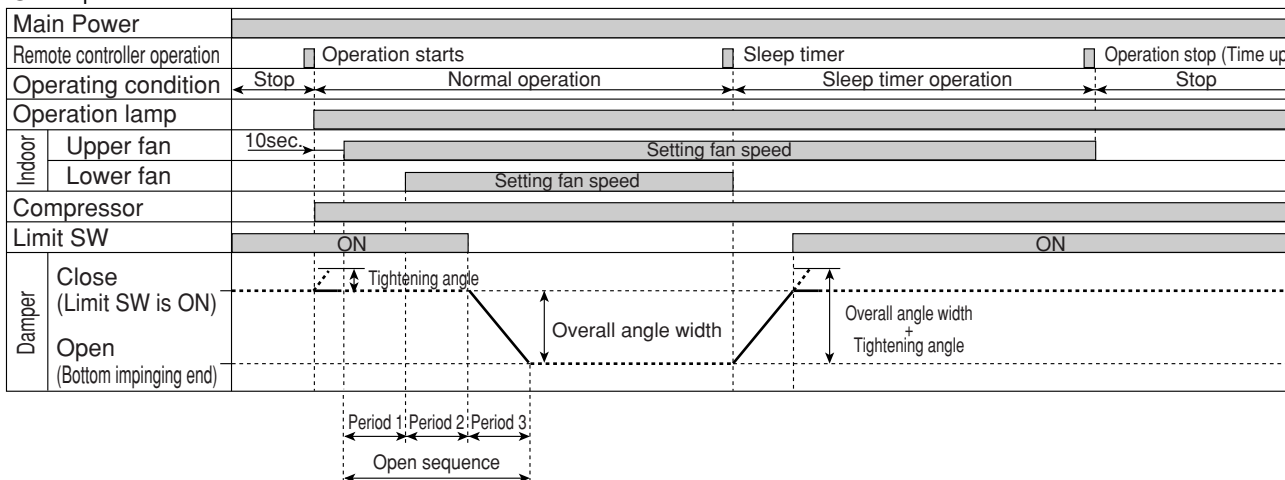

● Reversing valve defrost

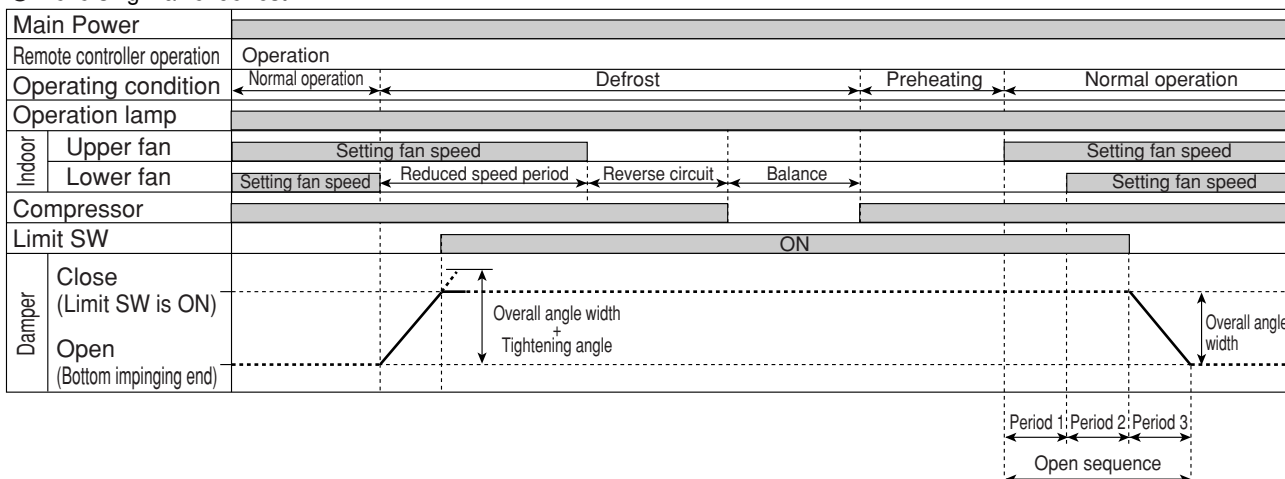

Cooling mode

The damper opens at cool dash (excluding smell prevention) and closes at the completion of cool dash.

The damper also closes at the moment the Air outlet SW is set to "  ".

● Dash operation (no smell prevention)

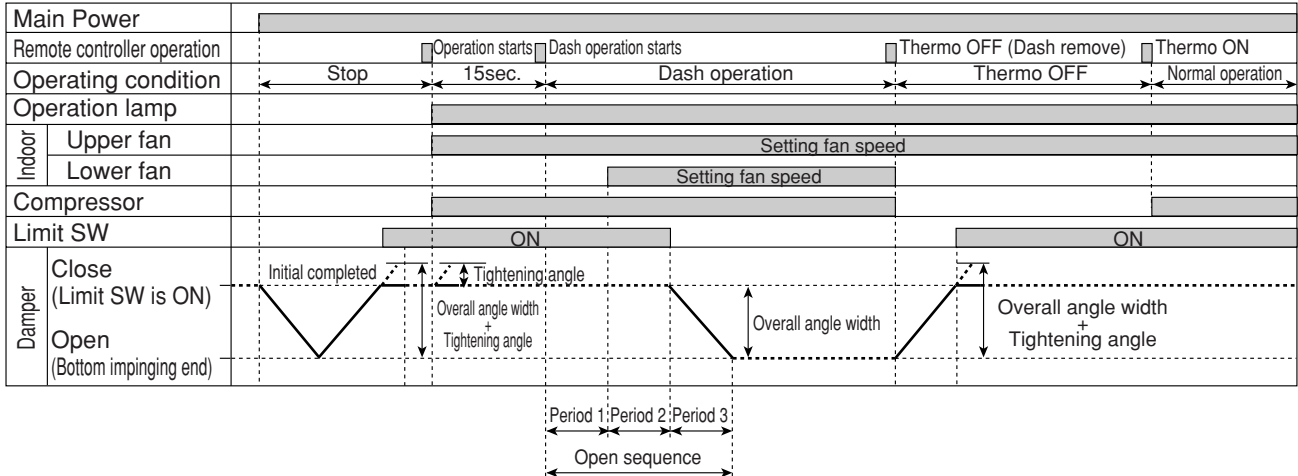

● Damper open operation (except dash)

This function is allowed when the damper open control select flag on EEPROM at cooling operation and fan speed of HI is set to [FLGET8 (3) = 1] and all the following conditions are satisfied. If any of the following conditions is unsatisfied, the damper will be closed.

- Operating mode: "Manual cooling"
- Preset fan speed: "Hi"
- Preset temperature: "16°C"
- $[\text{Room temperature (RMTM)} - \text{Final preset temperature (THERW2)}] \geq [\text{ONDOSA}]$ However, the condition (d) will be cancelled when $[\text{Room temperature (RMTM)} - \text{Final preset temperature (THERW2)}] \leq [\text{ONDOSA}]$.
- Thermo ON condition (ASTUS=3)

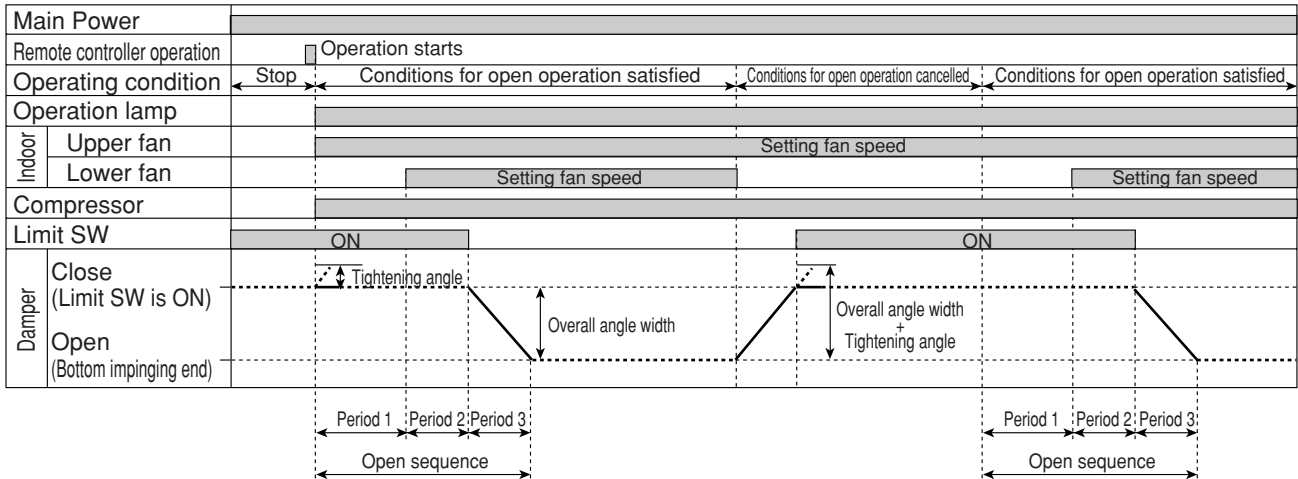

DESCRIPTION OF MAIN CIRCUIT OPERATION

Model RAF-25NH4, RAF-50NH4

1. Power Circuit

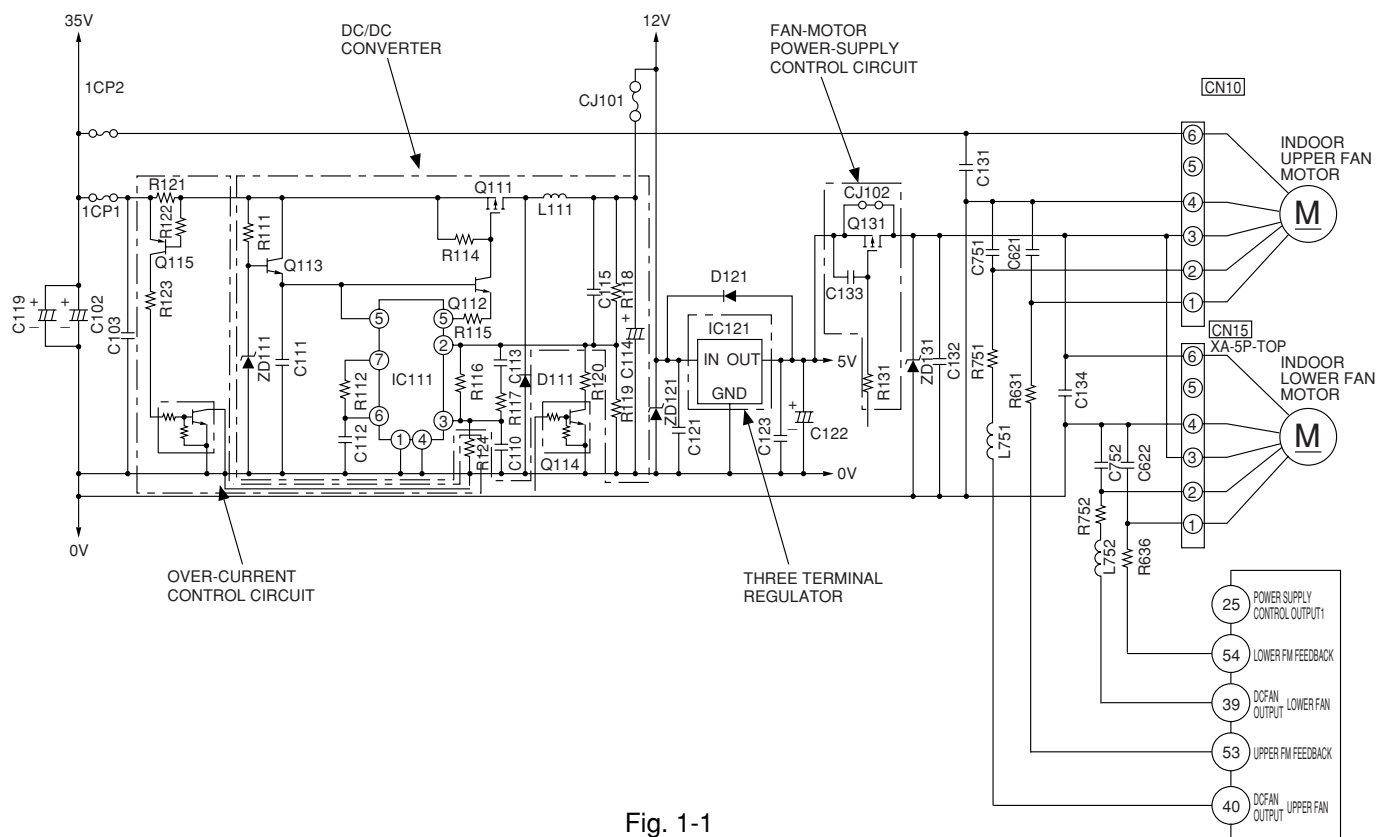

Fig. 1-1

Power to operate indoor unit (DC35V) is generated at the power supply in outdoor unit and it is sent to indoor unit through the connecting cord C and D.

Then, DC 12V (12V line) is generated using DC/DC converter from the voltage sent from outdoor unit, as the control voltage of 12V is required to drive the stepping motor and others.

Furthermore, 5V (5V line), which is necessary to drive the microcomputer and to control the fan motor, is generated using three-terminal regulator IC121.

2. Reset Circuit

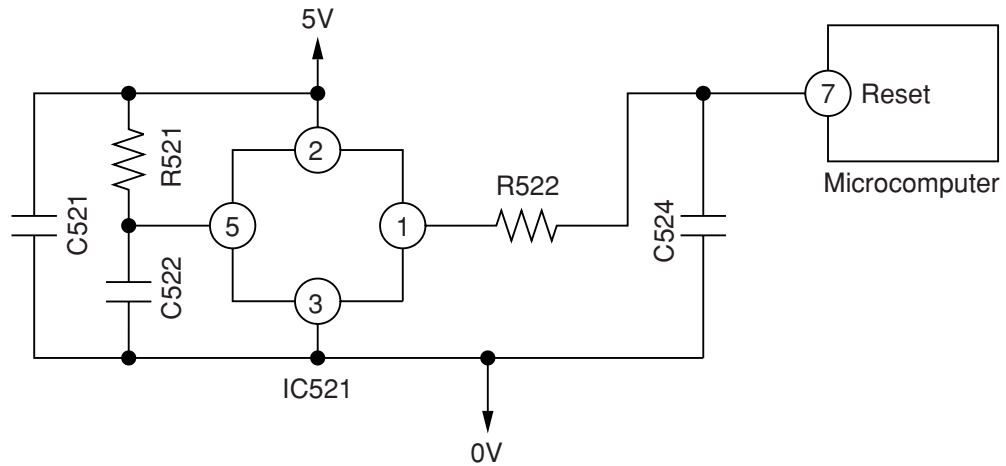

Fig. 2-1

Timing chart

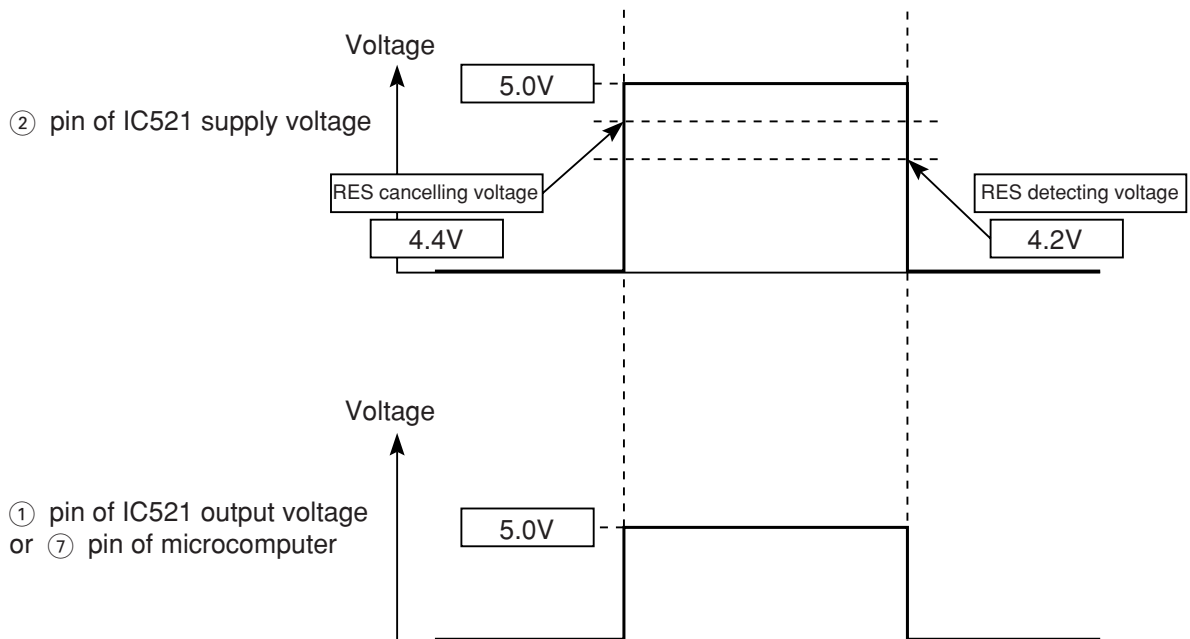

Fig. 2-2

- Reset circuit is to initialize the indoor unit microcomputer when switching ON the power or after recovering from power failure.
- Microcomputer operates when ⑦ pin of the indoor unit microcomputer (reset input) is “Lo” for resetting and “Hi” for hitting.
- Waveform of each part when switching ON the power and when shutting down is shown in the Fig. 2-2.
- After switching ON the power, ① pin of IC521 and ⑦ pin of microcomputer becomes Hi when DC5V line rises and reaches approximately 4.4V or higher. Then, resetting will be cancelled and microcomputer starts operating.
- After shutting down the power, ① pin of IC521 and ⑦ pin of microcomputer becomes Lo when DC5V line falls and reaches approximately 4.2V or lower. Then, the microcomputer will be in reset condition.

3. Room Temperature Thermistor Circuit

A room temperature thermistor circuit is shown in Fig. 3-1.

According to room temperature, the voltage of point ① becomes as it is shown in Fig. 3-2.

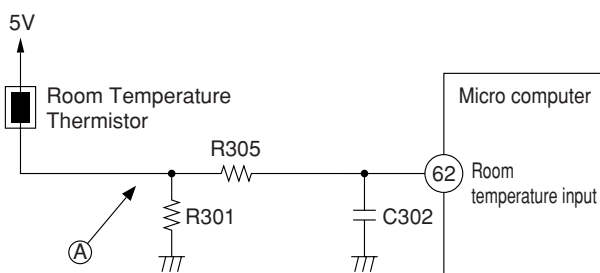

Fig. 3-1

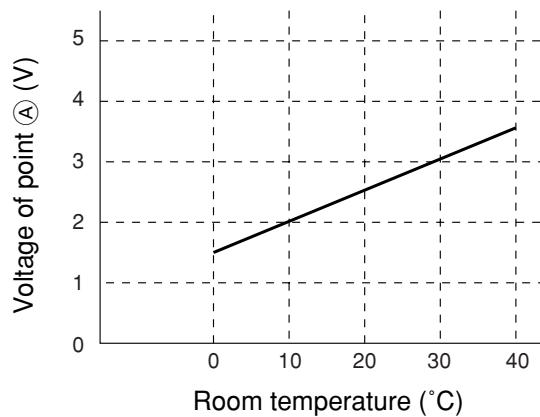

Fig. 3-2

4. Heat Exchanger Thermistor Circuit

Heat exchanger temperature is noticed inside the room

- (1) Preheating
- (2) Low-temperature defrosts at cooling-dehumidification operation time.
- (3) Not working of reversing valve or detection of opening of heat exchange thermistor is controlled.

According to heat exchange temperature, the voltage of point ① becomes as it is shown in Fig. 4-2.

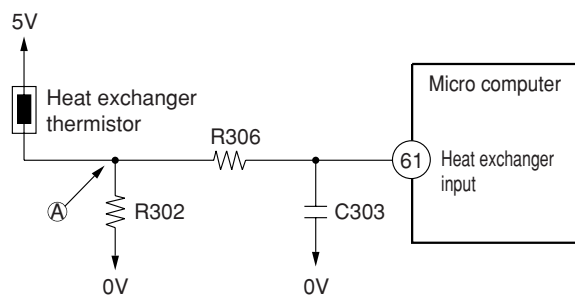

Fig. 4-1

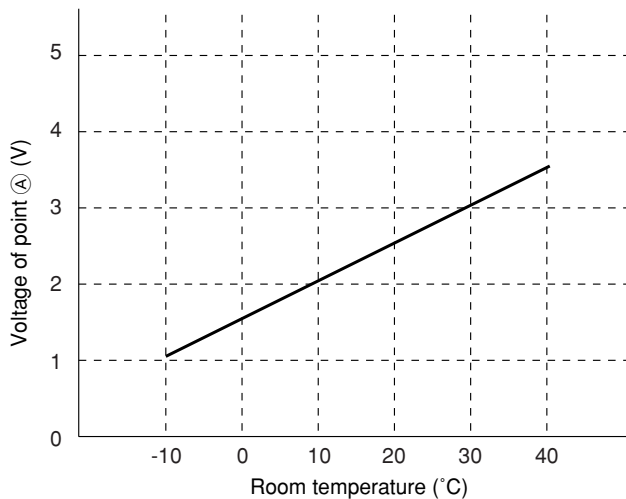

Fig. 4-2

6. Fan Motor Drive Circuit

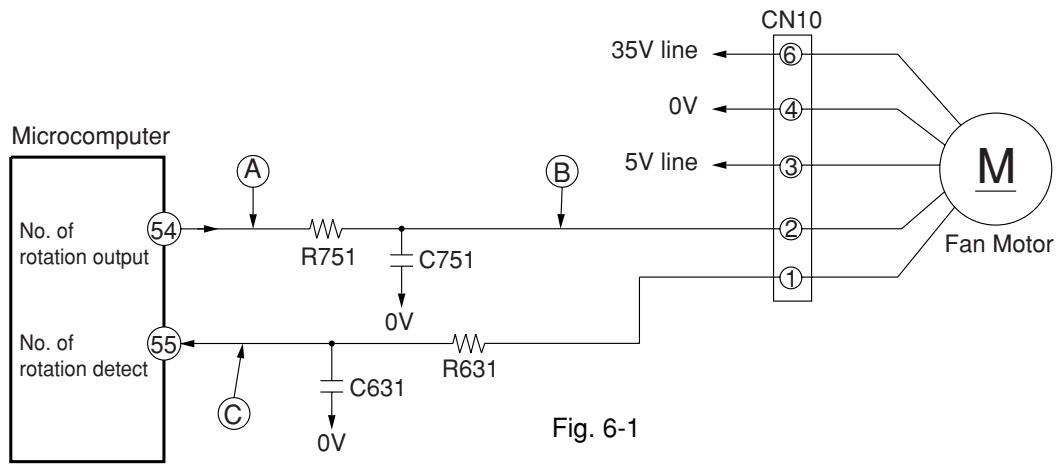

Fig. 6-1

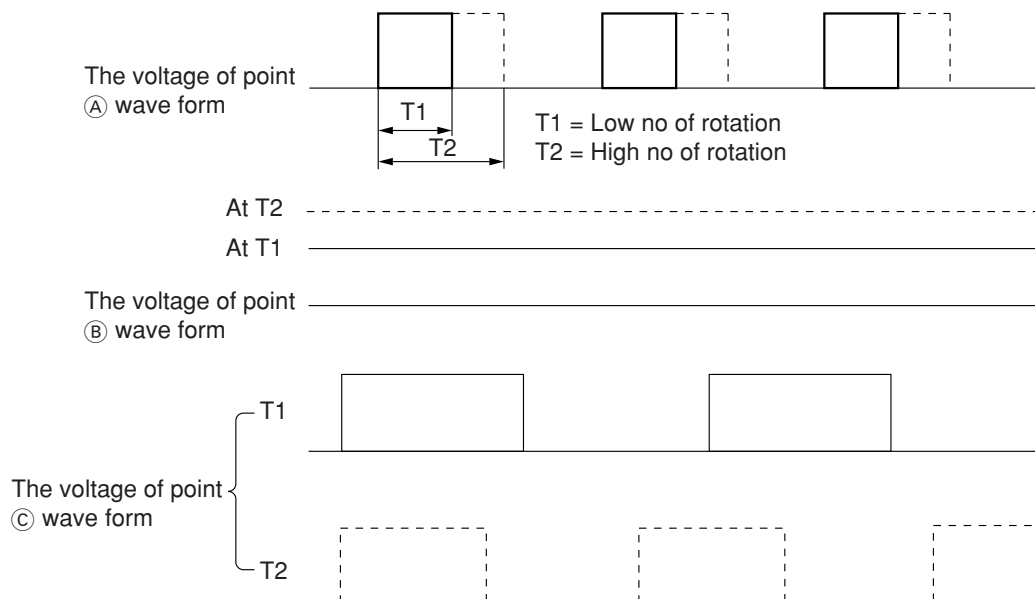

Fig. 6-2

- The 15.7 kHz PWM pulse shown in Fig. 6-2 from the microcomputer pin ⑤④ is output to point ①. The width of this pulse changes with instruction number of rotations.
- This pulse changes to analog voltage by R751 and C751 and it is applied to the fan motor as instruction voltage number of rotations. The relationship between the voltage of point ② and number of rotations becomes as shown in Fig. 6-3. (The gap may arise depending on the condition of unit.)
- The feedback pulse of number of rotation is output from the fan motor and input to microcomputer pin ⑤⑤. The frequency of this pulse is $12/60$ of the number of rotations. (Ex: $1000\text{min}^{-1} \times 12/60 = 200\text{Hz}$) The micro computer observes this frequency and to make it as the instruction number of rotation all the time, adjusts the output pulse width of pin ⑤④.
- If the feedback pulse becomes lower than 100min^{-1} caused by lock or failure of a fan motor, the fan output stops temporary as the fan lock is faulty. The pulse will output again after 10 seconds. If the abnormal in fan lock is detected twice in 10 minutes, the unit is completely stopped and change to the fault mode which the timer lamp blinks 10 times.

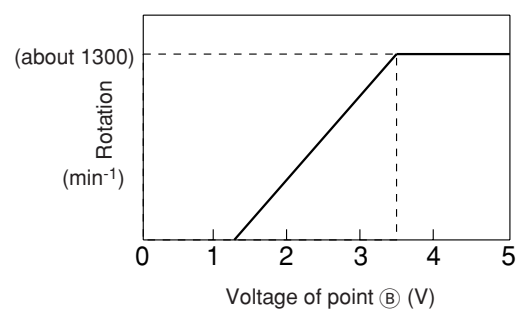

Fig. 6-3

2. Indoor/Outdoor Interface Circuit

- The interface circuit superimposes an interface signal on the DC 35V line supplied from the outdoor unit to perform communications between indoor and outdoor units. This circuit consists of a transmitting circuit which superimposes an interface signal transmit from the microcomputer on the DC 35V line and a transmitting circuit which detects the interface signal on the DC 35V line and outputs it to the microcomputer.
- Communications are performed by mutually transmitting and receiving the 4-frame outdoor request signal one frame of which consists of a leader of approx. 100 ms., start bit, 8-bit data and stop bit and the command signal with the same format transmit from the indoor unit.
- Communication signal from outdoor microcomputer to indoor microcomputer. At first outdoor microcomputer will send a request signal (SDO) to indoor microcomputer. A high-frequency IF signal approx. 38 KHz is generated and modulated by the request signal (SDO) inside the outdoor microcomputer then output to pin ① of microcomputer. This modulated IF signal is output to pin ③ of HIC and amplified by amp. This signal is superimposed to DC 35V line via C801 and L801.
To prevent erroneous reception, the outdoor microcomputer is designed so that it cannot receive a signal while it is outputting a request signal.
The receiving circuit in the indoor unit consists of a comparator and transistor. The interface signal from the outdoor unit on the DC 35V line is supplied to C821, where DC components are eliminated, and is then shaped by the comparator. The shaped signal is detected by diode, amplified by amp, and output to pin ④ of the indoor microcomputer.
Fig. 2-2 shows the voltages at each component when data is transferred from the outdoor microcomputer to the indoor microcomputer.
- Communication signal from indoor microcomputer to outdoor microcomputer. The request signal (SDO) generates by indoor microcomputer is output to pin ⑤, and amplifies by C801. IF signal approx. 38 kHz is generated by comparator, then modulate by the request signal from pin ⑤ of indoor microprocessor. This modulated IF signal is then amplified and superimposed to DC 35V line via L801 and C802 of indoor interface circuit.
Fig. 2-3 shows the voltages at each component when data is transferred from outdoor microcomputer to indoor microcomputer.
The circuit operation of the outdoor receiving circuit is same as indoor receiving circuit.

- Fig. 2-1 shows the interface circuit used for the indoor and outdoor microcomputers to communicate with each other.

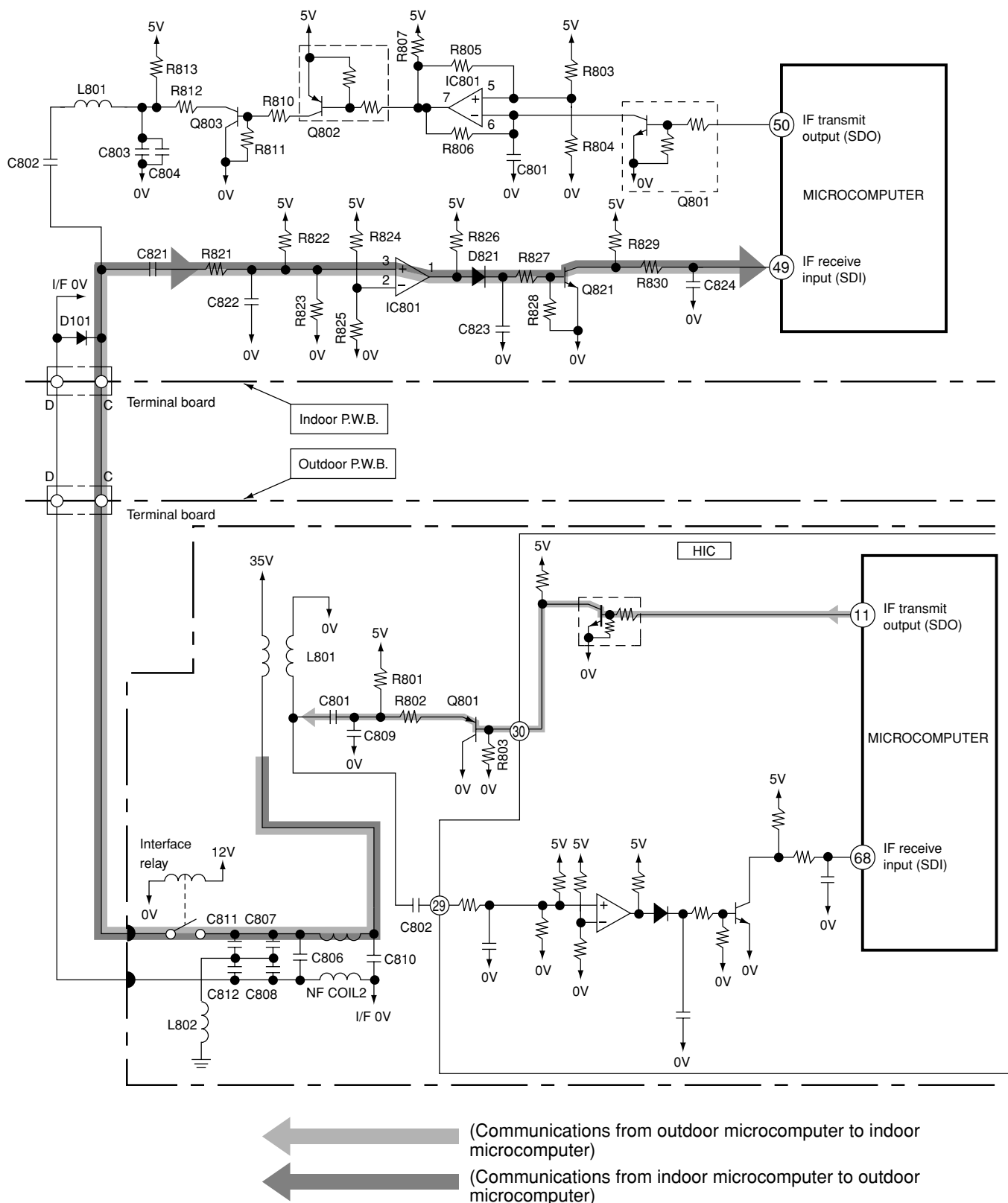

Fig. 2-1 Indoor/outdoor interface Circuit

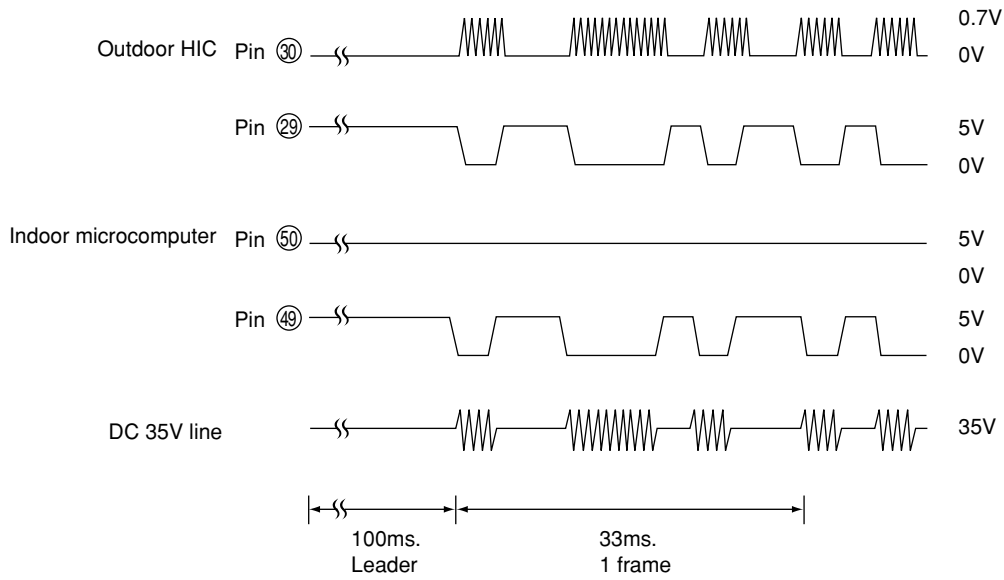

Fig. 2-2 Voltages Waveforms of indoor / Outdoor Microcomputers (Outdoor to Indoor Communications)

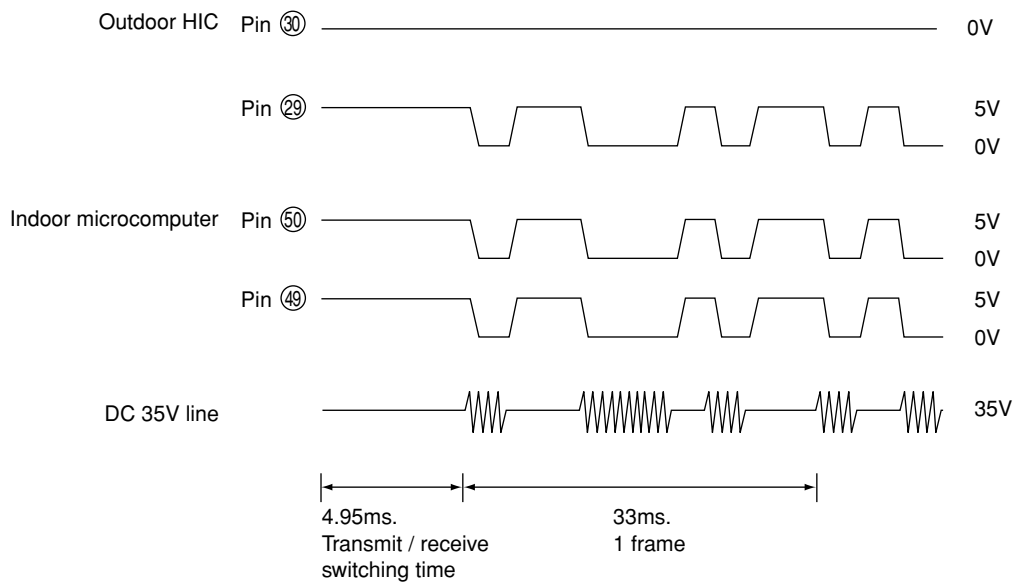

Fig. 2-3 Voltages Waveforms of indoor / Outdoor Microcomputers (Indoor to Outdoor Communications)

[Serial Communications Data]

(1) Outdoor message

Character No.	0								1								2								3													
Bit No.	7	6	5	4	3	2	1	0	7	6	5	4	3	2	1	0	7	6	5	4	3	2	1	0	7	6	5	4	3	2	1	0						
Contents	Multi-bit								During forced operation	Defrost request signal	Self-diagnosis (0 LSB)	Self-diagnosis (1)	Self-diagnosis (2)	Self-diagnosis (3 MSB)	Outside temperature (0 LSB)	Outside temperature (1)	Outside temperature (2)	Outside temperature (3)	Outside temperature (4)	Outside temperature (5)	Outside temperature (6)	Outside temperature (7 MSB)	Compressor during operation	Compressor during operation	Actual compressor rotation speed (0 LSB)	Actual compressor rotation speed (1)	Actual compressor rotation speed (2)	Actual compressor rotation speed (3)	Actual compressor rotation speed (4)	Actual compressor rotation speed (5 MSB)	Fan-7-step request							
Data	1/0	0	1/0	1/0	1/0	1/0	1/0	1/0	1/0	1/0	1/0	1/0	1/0	1/0	1/0	1/0	1/0	1/0	1/0	1/0	1/0	1/0	1/0	1/0	1/0	1/0	1/0	1/0	1/0	1/0	1	0	0	0	0	0	0	0

(2) Indoor message

Character No.	0								1								2								3														
Bit No.	7	6	5	4	3	2	1	0	7	6	5	4	3	2	1	0	7	6	5	4	3	2	1	0	7	6	5	4	3	2	1	0							
Contents	Operation mode (0 LSB)	Operation mode (1)	Operation mode (2 MSB)	Indoor in-operation bit	Capacity code (0 LSB)	Capacity code (1)	Capacity code (2)	Capacity code (3 MSB)	Fan (0 LSB)	Fan (1)	Fan (2 MSB)	2-way valve	Reversing valve			Compressor ON	Compressor command speed (0 LSB)	Compressor command speed (1)	Compressor command speed (2)	Compressor command speed (3)	Compressor command speed (4)	Compressor command speed (5)	Compressor command speed (6)	Compressor command speed (7 MSB)	15/20(A)	OVL up							Compressor minimum rotation speed (0 LSB)	Compressor minimum rotation speed (1)	Compressor minimum rotation speed (2)	Compressor minimum rotation speed (3)	Compressor minimum rotation speed (4 MSB)		
Data	1/0	1/0	1/0	1/0	0	0	0	0	1/0	1/0	1/0	0	1/0	0	1/0	1/0	1/0	1/0	1/0	1/0	1/0	1/0	1/0	1/0	1/0	1/0	1/0	1/0	1/0	1/0	1/0	1/0	1/0	1/0	1/0	1/0	1/0	1/0	1/0

SERVICE CALL Q & A

Model RAF-25NH4 / RAC-25NH4
RAF-50NH4 / RAC-50NH4

COOLING MODE

Q1 The compressor has stopped suddenly during cooling operation.



A1 Check if the indoor heat exchanger is frosted. Wait for 3-4 minutes until it is defrosted.

If the air conditioner operates in cooling mode when it is cold, the evaporator may get frosted.

DEHUMIDIFYING MODE

Q1 Sound of running water is heard from indoor unit during dehumidifying.



A1 Normal sound when refrigerant flows in pipe.

Q2 Compressor occasionally does not operate during dehumidifying.



A2 Compressor may not operate when room temperature is 10°C or less. It also stops when the humidity is preset humidity or less.

Q3 Cold air comes out during a dehumidifying operation.



A3 To improve the dehumidification efficiency performs quiet fan operation. Therefore the air is cold and it is not a malfunction.

Q4 The operation does not stop even by setting the temperature higher than room temperature on the remote controller.



A4 It sets to perform dehumidifying operation by setting the temperature slightly lower than remote controller setting.

HEATING MODE

Q1 The circulation stops occasionally during Heating mode.



A1 It occurs during defrosting. Wait for 5-10 minutes until the condenser is defrosted.

Q2 When the fan speed is set at HIGH or MED, the flow is actually Weak.



A2 At the beginning of heating, the fan speed remains LOW for 30 seconds. If HIGH is selected, it switches to LOW and again to MED after additional 30 seconds.

Q3 Heating operation stops while the temperature is preset at "30".



A3 If temperature is high in the outdoor, heating operation may stop to protect internal devices.

AUTO FRESH DEFROSTING

Q1 After the ON/OFF button is pressed to stop heating, the outdoor unit is still working with the OPERATION lamp lighting.



A1 Auto Fresh Defrosting is carried out : the system checks the outdoor heat exchanger and defrosts it as necessary before stopping operation.

AUTO OPERATION

Q1 Fan speed does not change when fan speed selector is changed during auto operation.



A1 At this point fan speed is automatic.

Q2 How is the automatic operation mode determined?



A2 According to the room temperature and outside temperature, heating or cooling operation is automatically selected. Refer to the basic operation section.

Q3 The room temperature cannot be controlled at an automatic operation.



A3 It is automatically set as follows.
At cooling: and heating: Set at 22°C
The room temperature setting can be raised 3°C by “^” or lowered 3°C by “v”.

NICE TEMPERATURE RESERVATION

Q1 When on-timer has been programmed, operation starts before the preset time has been reached.



A1 This is because “Nice temperature reservation” function is operating. This function starts operation earlier so the preset temperature is reached at the preset time. Operation may start maximum 60 minutes before the preset time.

Q2 Does “Nice temperature reservation” function operate during dehumidifying?



A2 It does not work. It works only during cooling and heating.

Q3 Even if the same time is preset, the operation start time varies.



A3 This is because “Nice temperature reservation” function is operating. The start time varies according to the load of room. Since load varies greatly during heating, the operation start time is corrected, so it will vary each day.

AT STARTING OPERATION

Q1 When only the power switch is turned on, the damper at the bottom air outlet moves even if the START/STOP button is not pressed.



A1 To ensure correct opening and closing of the damper, the damper will move when power is turned on or the unit is to be operated in order to check its fully opened and closed positions.

Q2 When the heating operation is started, the indoor fan does not start immediately and the damper at the bottom air outlet occasionally does not open.



A2 This is because the preheating device is working. It will not start to drive the fan until the refrigerating cycle warms up and warm air blows. Wait for a while. The damper does not open either during preheating or for one minute after preheating is finished.

Q3 When the unit built behind the gallery (lattice door) is to be started immediately after it has stopped, the unit occasionally will not start.



A3 Such a phenomenon may occur with built-in installation where heat is likely to be stuffy. Install the unit as near to the lattice door as possible so that air is not short-circuited, or provide a partition between the unit and lattice door.

OTHERS

Q1 The indoor fan varies among high air flow, low air flow and breeze in the auto fan speed mode. (Heating operation)



A1 This is because the cool wind prevention function is operating, and does not indicate a fault.

The heat exchanger temperature is sensed in the auto fan speed mode. When the temperature is low, the fan speed varies among high air flow, low air flow and breeze.

Q2 Loud noise from the outdoor unit is heard when operation is started.



A2 When operation is started, the compressor rotation speed goes to maximum to increase the heating or cooling capability, so noise becomes slightly louder. This does not indicate a fault.

Q3 Noise from the outdoor unit occasionally changes.



A3 The compressor rotation speed changes according to the difference between the thermostat set temperature and room temperature. This does not indicate a fault.

Q4 There is a difference between the set temperature and room temperature.



A4 There may be a difference between the set temperature and room temperature because of construction of room, air current, etc. Set the temperature at a comfortable for the space.

- Q5** Air does not flow immediately after operation is started.
- A5** Preliminary operation is performed for one minute when the power switch on and heating or dehumidifying is set. The operation lamp blinks during this time for heating. This does not indicate a fault.
- Q6** Mold in the room cannot be inhibited even after performing the air conditioner drying operation.
- A6** Air conditioner drying operation is to dry the interior of the indoor unit to inhibit the growth of mold. It is not to inhibit the mold growth in the room.
- Q7** The interior of the indoor unit seems to be still damp even after performing the air conditioner drying operation.
- A7** Condition of the interior of the indoor unit varies depending on usage of the unit and condition of the indoor unit. If it is not dried after the first try, perform the drying more than one time for better effect.
- Q8** Even if the air conditioner drying is performed using the remote controller during the unit operation or timer programming, the air conditioner drying operation does not start.
- A8** To perform the air conditioner drying, stop the unit operation or programming beforehand.
- Q9** The unit is operated after built-in installation (behind the lattice door). It turns off for a long time and the room is not warmed (cooled).
- A9** Check to see if warm (cool) air is being short-circuited behind the lattice door. A short-circuit is likely to occur when the deflector position is not appropriate, the lattice does not have a big enough opening, and/or the unit is installed in the inner part. Install the unit as near the lattice door as possible.
- Q10** Strange sound is occasionally heard from the bottom air outlet.
- A10** When the damper is switched, scrambling of air will occur between the top and bottom outlets due to the set fan speed during switching and filter clogged state, which, may generate some sound.

DISASSEMBLY AND REASSEMBLY

MODEL RAF-25NH4, RAF-50NH4

1. AIR FILTER

Clean the air filter, as it removes dust inside the room.

Be sure to clean the filter once every two weeks so as not to consume electricity unnecessarily.

PROCEDURE

1 Open the front panel.

- To open the front panel, use the remote controller to stop unit operation. Then press the two "≡" sections below PUSH at the top left and right corners of the front panel.
- Grasp the left and right sides of the front panel and open it toward you.

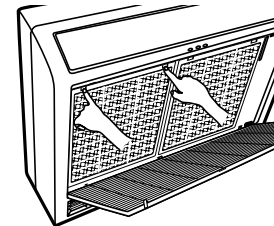
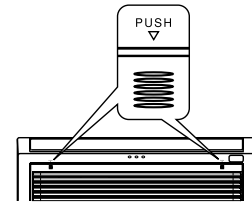

2 Remove the filters.

3 Remove dust of the filters using a vacuum cleaner.

- After using neutral detergent, wash with clean water and dry in shade.

4 Attach the filter.

- Attaching the filters which are placed the surface written "FRONT" up.



5 Close the front panel.

- To close the front panel, press the two "≡" sections below PUSH at the top left and right corners of the front panel.
- Press the upper center part of the front panel to close properly.

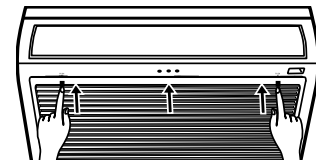

2. FRONT PANEL

- Be sure to use both hands to grasp the front panel when removing it or attaching it.
- The front panel may be installed up or down to suit user preference.

Removing

- ① Press the hook found at the tip of the resin band installed inside the front panel's right section to remove the resin band.

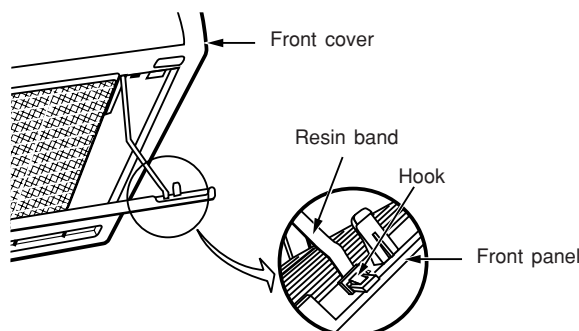

- ② Pull the front panel down toward you and once fully open, pull it to remove.

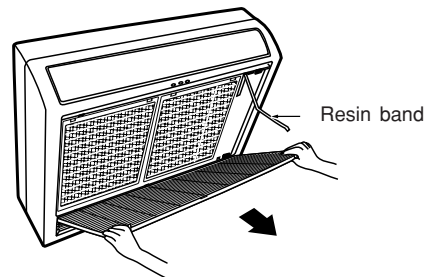

Attaching

- ① Attach three front panel bearings to the axis of the front cover.

- ② Insert the tip of the resin band into the hole of the protrusion inside the right section of the front panel.

3. FRONT COVER

Remove the four securing screws of the front cover, and then pull the front cover towards you.

When attaching the front cover, insert the front cover tabs into these openings.

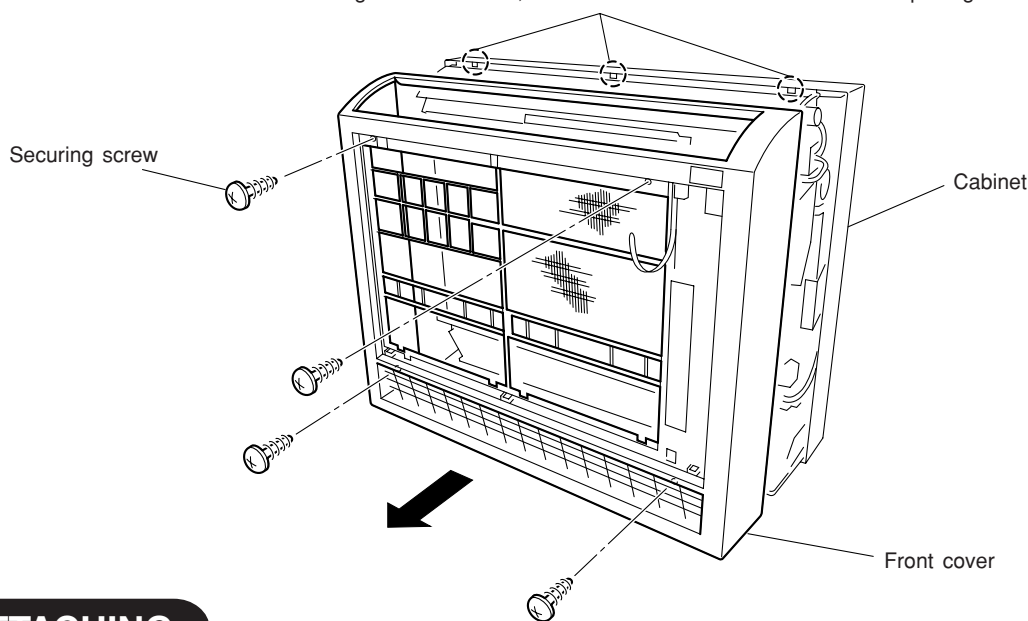

ATTACHING

When attaching the front cover, fit the three tabs on the top of the front cover so that they enter the openings on the top frame (insert from a slightly raised position). Be sure that the tabs are inserted correctly.

4. INDICATION P.W.B.

- (1) Use a screwdriver or other such tool to push up the tabs of the section A from below, and remove.
- (2) As shown in the following diagram, slide the L-shaped tab on the indication P.W.B. to the right so that it enters the hole in the top frame. You can then remove the indication P.W.B. by pulling upwards.

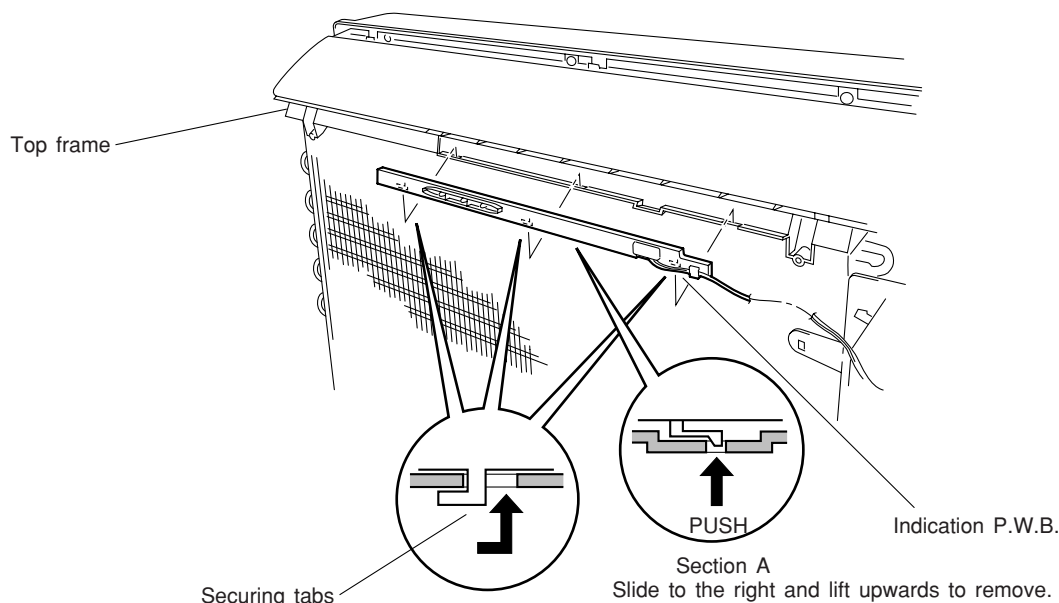

5. TOP FRAME

- (1) Remove the front panel, and then remove the front cover.
- (2) Remove the indication P.W.B..
- (3) Remove the cord from the stepping motor of the air deflector.
- (4) Remove the three securing screws of the top frame, and pull the frame towards you.

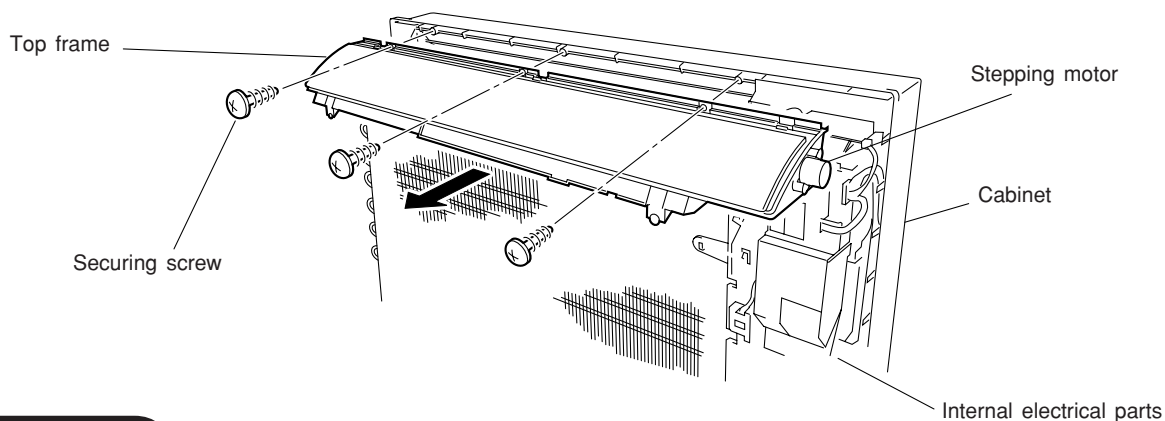

ATTACHING

- (1) When attaching the top frame, align the left and right of the top frame with the inside of the guides on the cabinet, and then push the top frame straight to the back.
Note: Check to see that there is no space between the top frame and the cabinet.
- (2) Fasten the three securing screws, and then check to see that the top frame does not slip to the side.

6. DISCHARGE FRAME

- (1) Remove the three securing screws of the discharge frame.
- (2) Remove the screw on the rat prevention cover.
- (3) Lower the rear side of the discharge frame, remove the tab on the interfit section, and then pull out the discharge frame towards you.

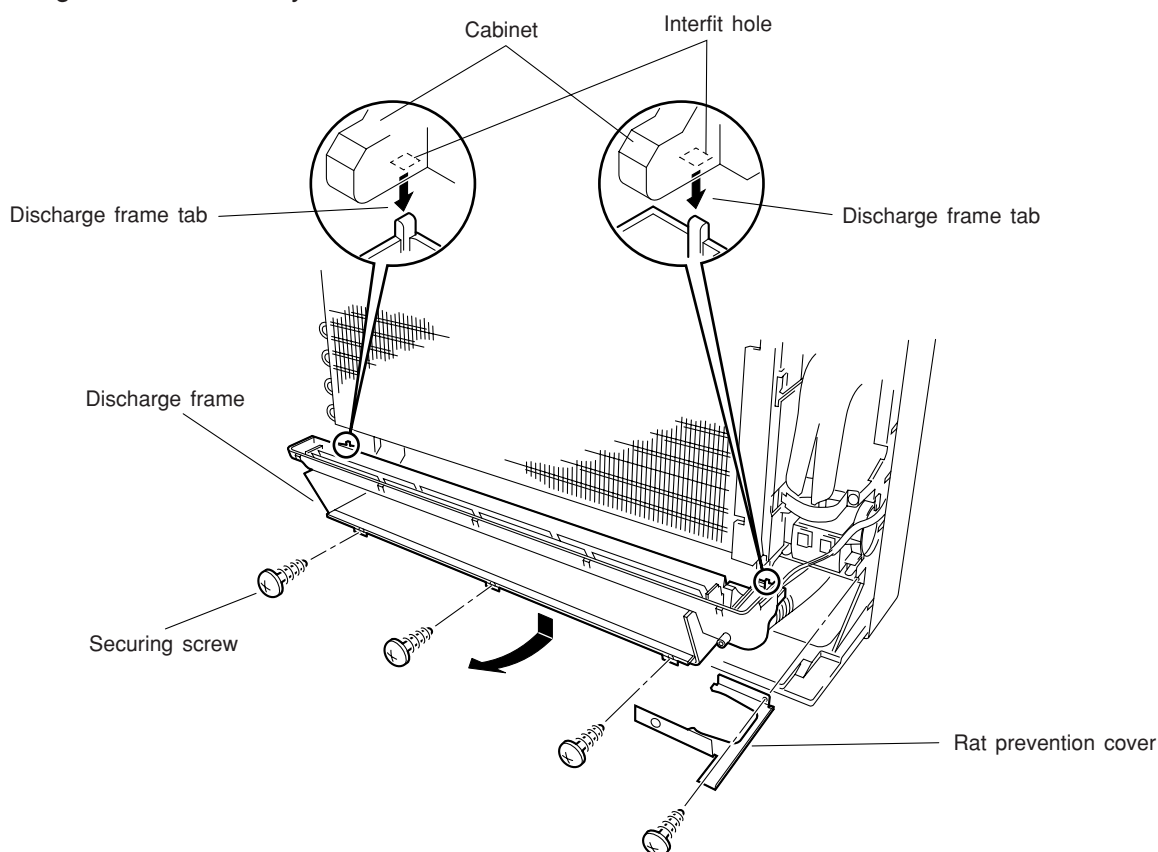

ATTACHING

- (1) Align the tabs to the left and the right of the discharge frame with the holes in the cabinet, lift up the discharge frame while pushing it to the rear, and keep pushing until it clicks into place.
Note: After installing, check to see that the cabinet and the discharge frame are correctly fitted together, as shown in section B.

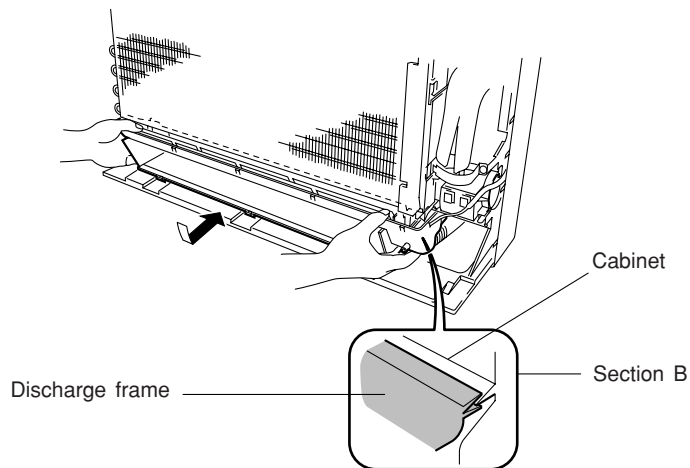

7. DAMPER MOTOR-DAMPER LIMIT SWITCH

- (1) Remove the securing screws of the damper limit switch.
- (2) Remove the two securing screws of the damper motor (stepping motor).
- (3) Pull out the damper motor and the damper limit switch, and then remove them.

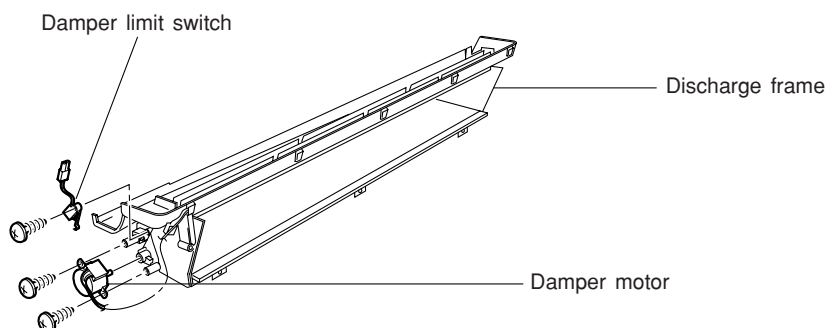

ATTACHING

Note: After removing the damper limit switch, check to see that the switch operates when the damper goes upwards.

8. NEGATIVE ION GENERATING DEVICE

- (1) Remove the front panel, and then remove the front cover.
- (2) Remove the display P.W.B..
- (3) Remove the cord from the stepping motor of the air deflector.
- (4) Remove the top frame.
- (5) Use a flat-blade screwdriver to slightly lift the high voltage generating device, and then pull it towards you.
- (6) Remove the securing screw, and remove the negative ion generating device.

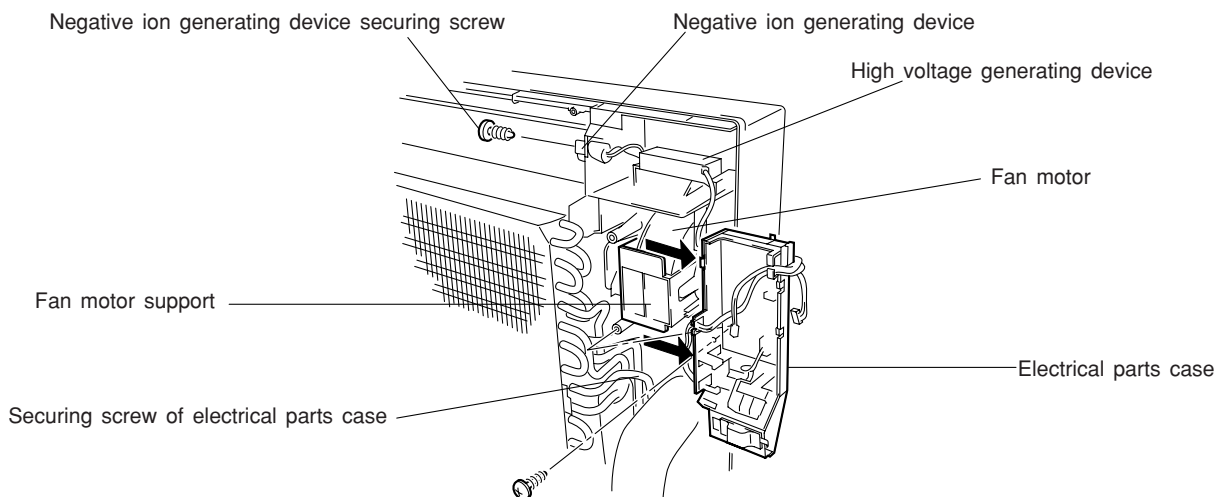

ATTACHING

Note - Don't touch the ion generating tip when replacing the electrode.

- The ion generating tip must be replaced if it is bent.
- Clean the electrode with a toothbrush if dust gathers on the electrode. Even if this happens, be sure not to touch the ion generating tip.

9. FAN MOTOR - TANGENTIAL AIR FLOW FAN

- (1) Remove the front panel, and then remove the front cover.
- (2) Remove the display P.W.B..
- (3) Remove the cord from the stepping motor of the air deflector.
- (4) Remove the top frame.
- (5) Remove the electrical parts cover, the fan motor cord, the negative ion generating device cord, and the heat exchanger thermostat cord.
- (6) Remove the pipe cover from the heat exchanger.
- (7) Remove the securing screw of the electrical parts case, then slide the electrical parts case to the right while removing it from the fan motor support.

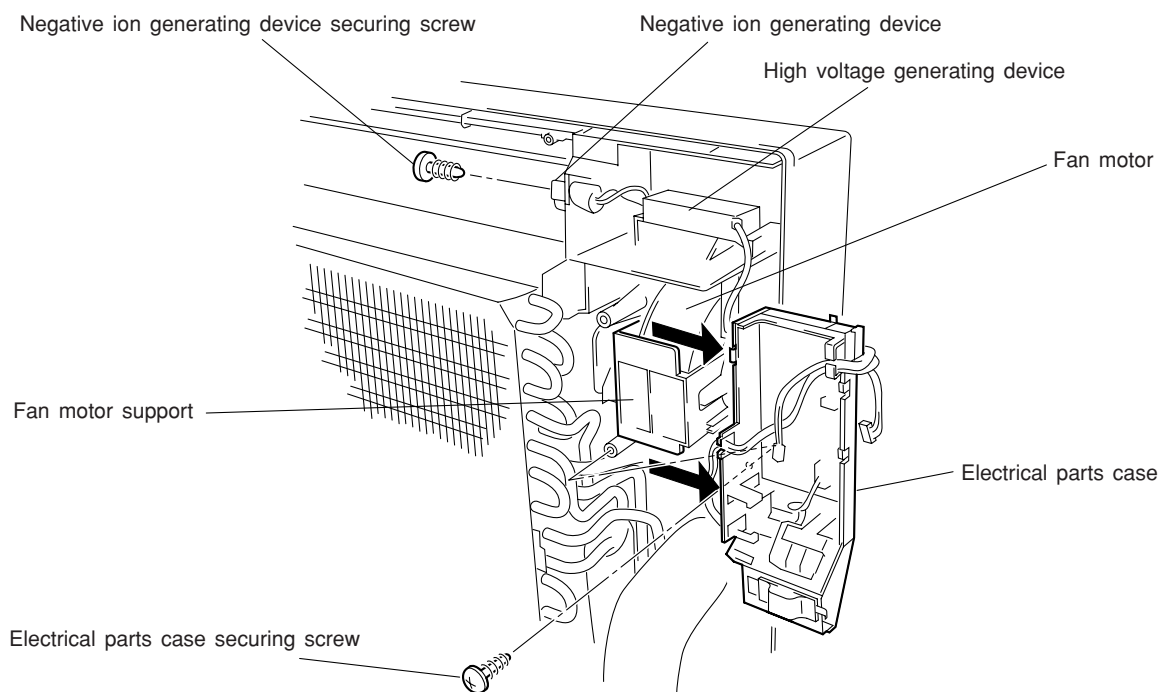

- (8) Use a flat-blade screwdriver or other such tool to lift up the central securing tab and the left side of the heat exchanger.
- (9) Remove the upper and lower fan covers.
 - As shown in the diagram below, bend the lever (tab) securing the fan cover inwards while pulling out the heat exchanger towards you.
 - Bend the lever (tab) of the lower fan cover inwards while pulling out the lower fan cover slightly upwards and towards you.

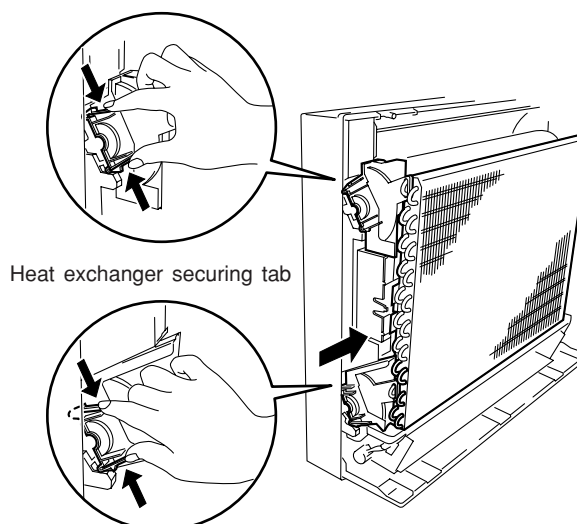

- (10) Use a minus screwdriver or other such tool to raise the two tabs (see arrows in diagram below) securing the right side of the heat exchanger, then pull out the heat exchanger towards you.
- (11) Pull the lower section of the fan motor support towards you while raising the two levers (tabs) on the left and right of the upper and lower sides of the fan motor support securing the fan motor, and then remove the fan motor support.

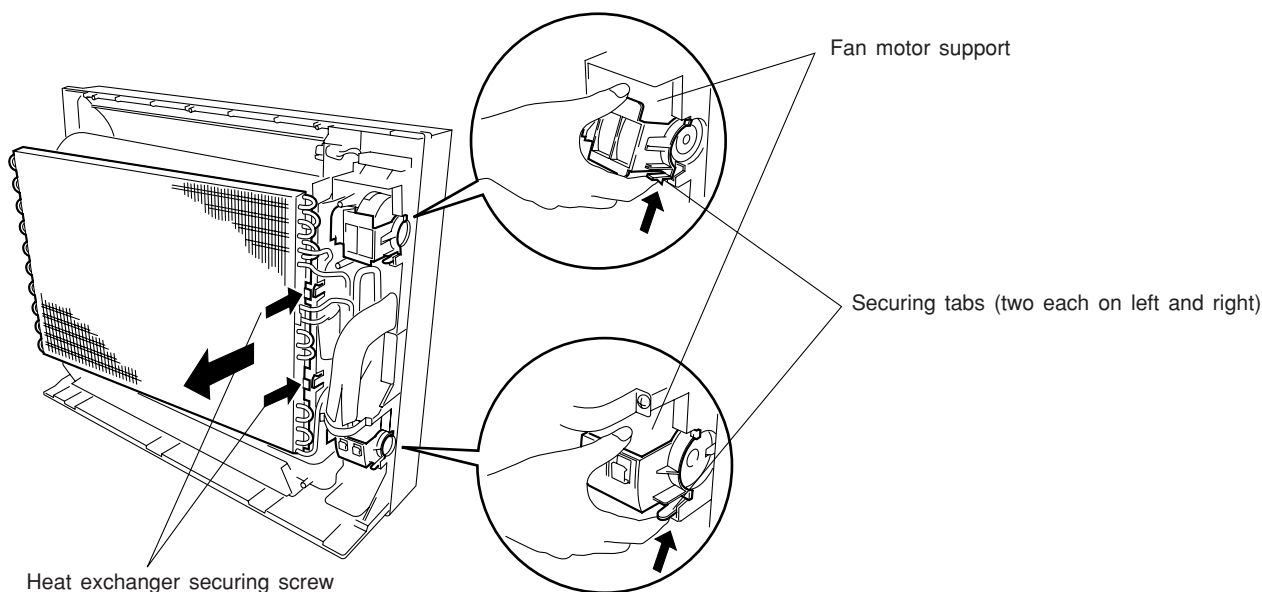

- (12) Loosen the screws securing the tangential air flow fan and the motor, and then remove the tangential air flow fan and the fan motor.

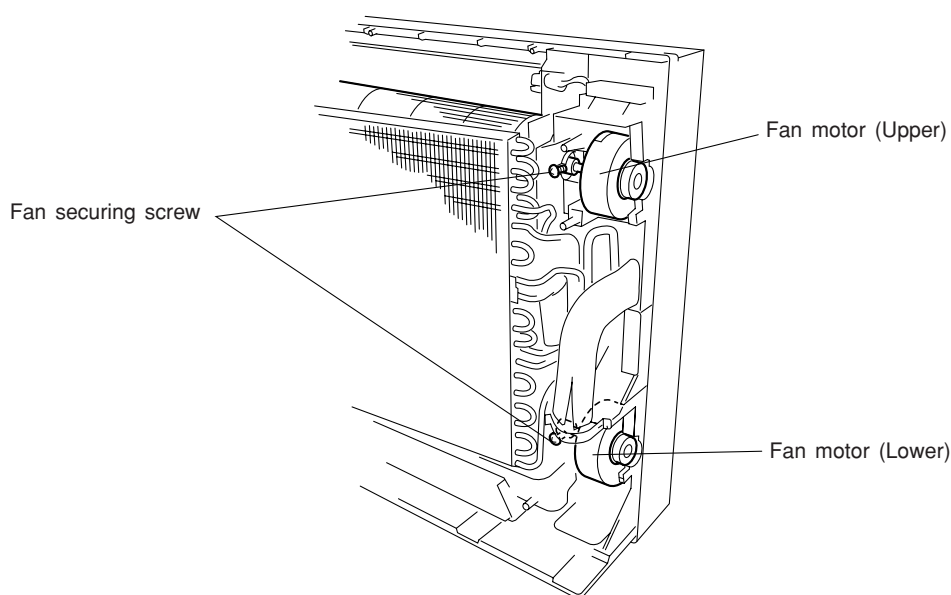

ATTACHING

- (1) When attaching the tangential air flow fan and the fan motor, insert the axis of the fan motor into the boss of the tangential air flow fan. Insert the fan support into the boss on the right side of the tangential air flow fan, and then insert into the fan support securing groove on the cabinet.
- (2) Fasten the securing screws of the fan.
Note: Rotate the fan by hand, and check to see that it does not strike the inside section.

TROUBLE SHOOTING

Model RAF-25NH4 / RAC-25NH4
RAF-50NH4 / RAC-50NH4

PRECAUTIONS FOR CHECKING



- Remember that the 0V line is biased to 155-170V in reference to the ground level.
- Also note that it takes about 10 minutes until the voltage fall after the power switch is turned off.

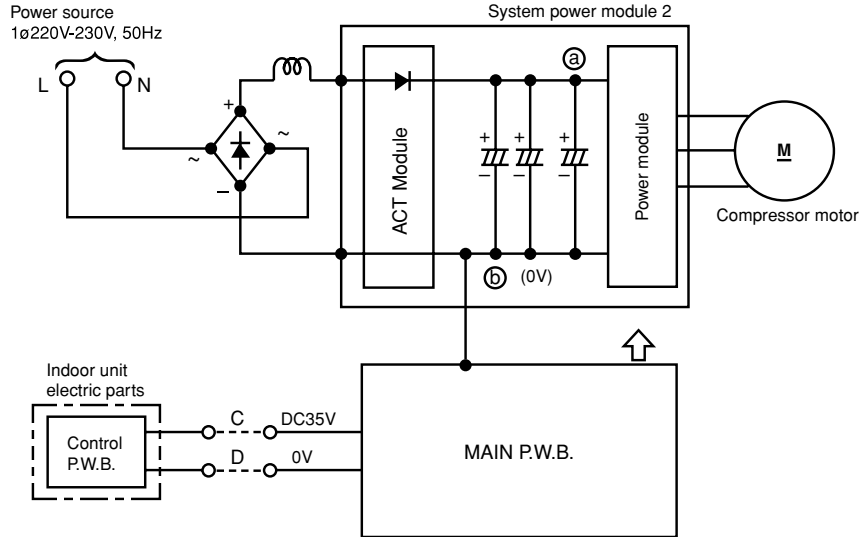

Across (a) – (b) (0V line)..... approx 260-360V
 Across (a) – ground..... approx 155-170V
 Across (b) (0V line)– ground..... approx 155-170V



When using an oscilloscope, never ground it. Don't forget that high voltages as noted above may apply to the oscilloscope.

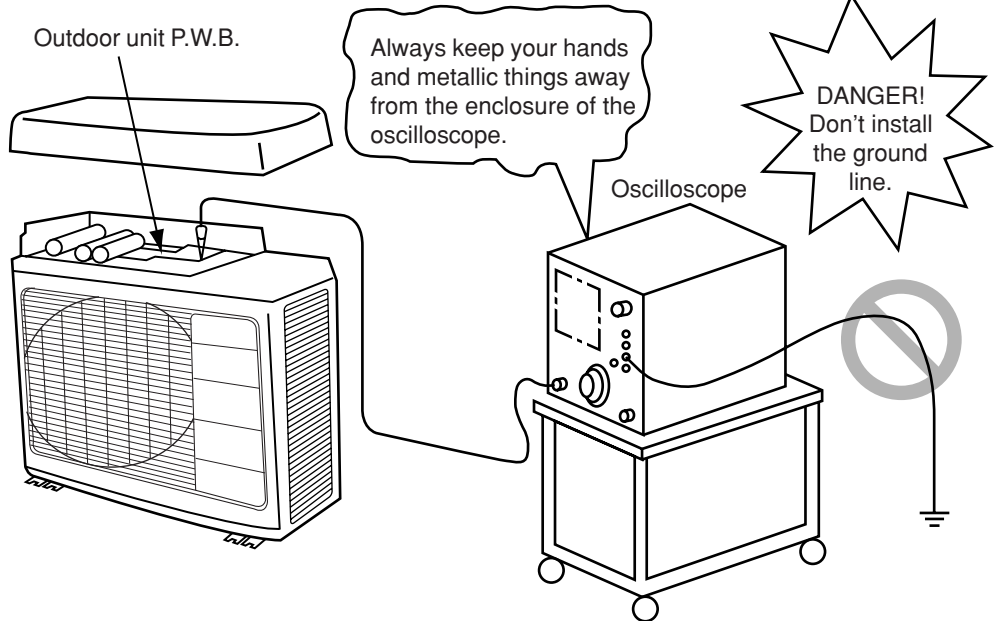

DISCHARGE PROCEDURE AND POWER SHUT OFF METHOD FOR POWER CIRCUIT



WARNING

Caution

- Voltage of about 300-330V is charged between both ends of smoothing capacitors
- During continuity check for each part of circuit in indoor unit electrical parts, disconnect red/gray lead wire connected from diode stack to system power module (SPM2) to prevent secondary trouble. (Be sure to discharge smoothing capacitor)

1. Turn OFF the Power supply to the outdoor unit.
2. After power is turned off, wait for 10 minutes or more. Then, remove electrical parts cover and apply soldering iron of 30 to 75W for 15 seconds or more to P2 and N1 terminals on system power module, in order to discharge voltage in smoothing capacitor.
3. Remove receptacle of red/gray lead wire connected to system power module from diode stack before performing operation check of each circuit.

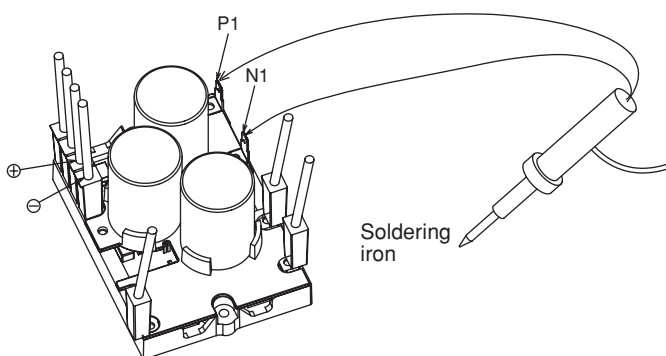

System power module

Do not use a soldering iron with transformer: If one is used, thermal fuse inside transformer will be blown

As shown above, apply soldering iron to metal parts (receptacle) inside the sleeve corresponding to P1 and N1 terminals of system power module: Do this with smoothing capacitors kept connected. By removing red/gray lead wire from diode stack, power supply can be shut off. (corresponding to \oplus and \ominus terminals of system power module)

RAC-25NH4

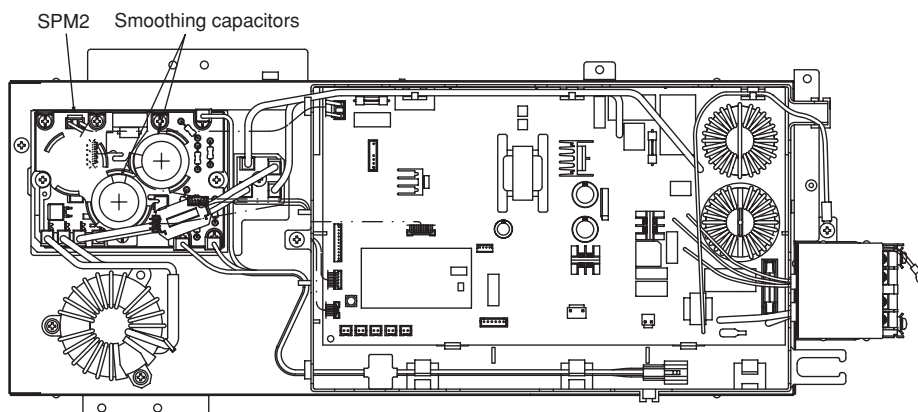

RAC-50NH4

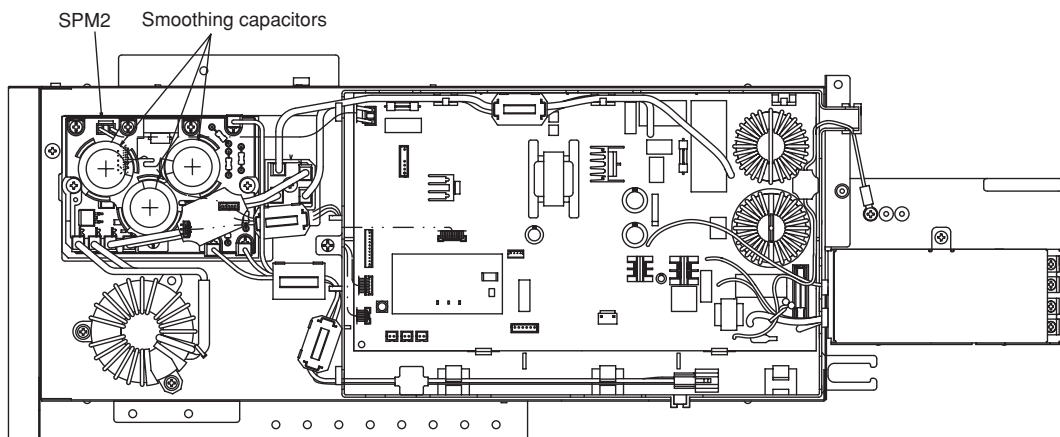

CHECKING THE INDOOR/OUTDOOR UNIT ELECTRICAL PARTS AND REFRIGERATING CYCLE



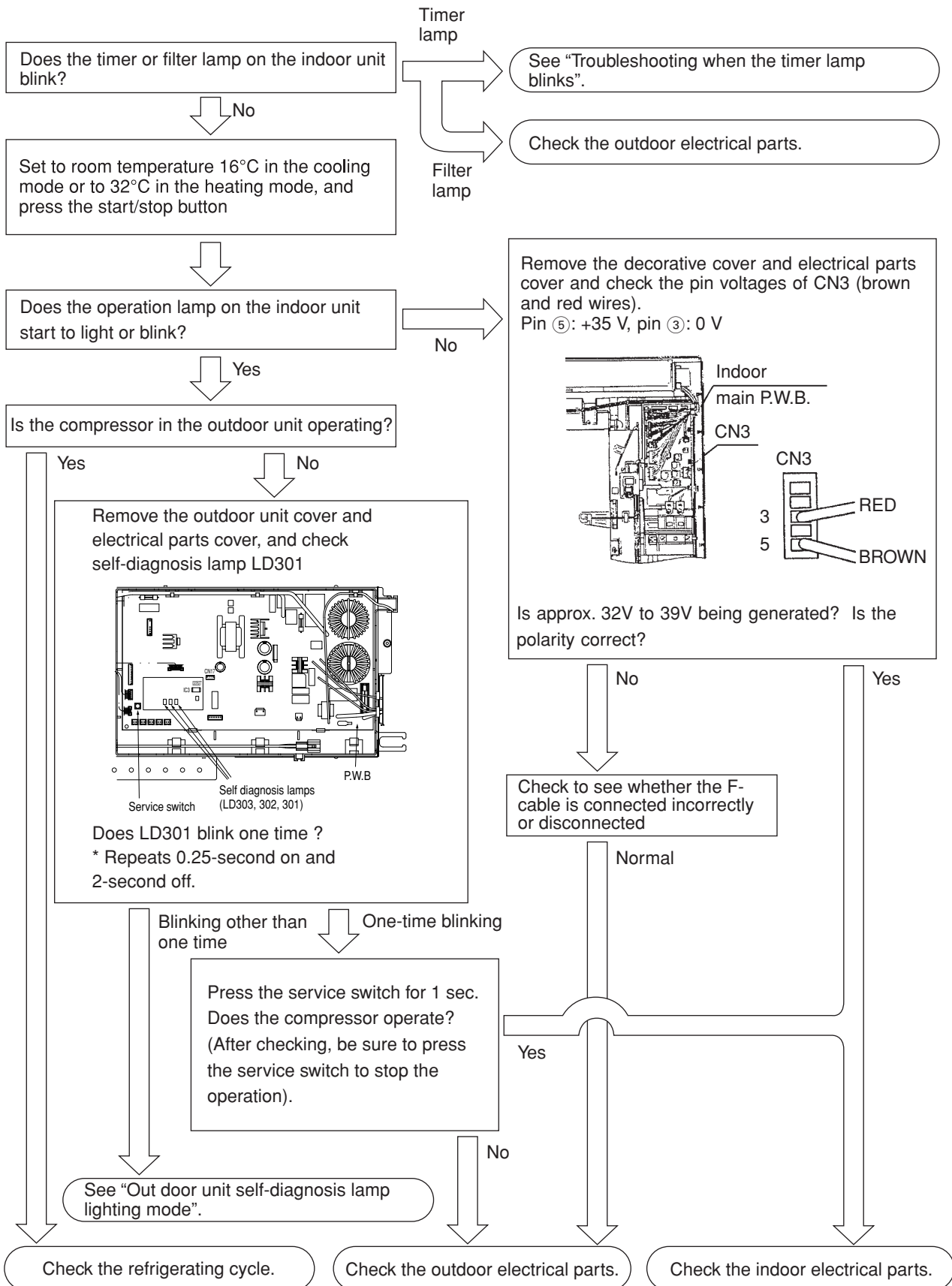





**Model RAF-25NH4 / RAC-25NH4
RAF-50NH4 / RAC-50NH4**



TROUBLE SHOOTING WHEN THE TIMER and FILTER LAMP BLINKS











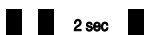

Model RAF-25NH4, RAF-50NH4

When the timer lamp on the display section of the indoor unit blinks, refer to the following table.

Lamp blinking mode	Main defective
 2 sec ----- Once	Reversing valve defective
 2 sec ----- 2 Times	Forced operation of outdoor unit
 2 sec ----- 3 Times	Indoor/Outdoor interface defective
 2 sec ----- 5 Times	Abnormal rotating numbers of DC fan motor (Lower)
 2 sec ----- 8 Times	Damper defective
 2 sec ----- 9 Times	Indoor sensor defective
 2 sec ----- 10 Times	Abnormal rotating numbers of DC fan motor (Upper)
※2  2 sec ----- 13 Times	IC401 defective

( -- Lights for 0.35 sec at interval of 0.35 sec.)

When the filter lamp on the display section of the indoor unit blinks, refer to the following table.

Lamp blinking mode	Main defective
 2 sec ----- 2 Times	Peak current cut
 2 sec ----- 3 Times	Abnormal low speed rotation
 2 sec ----- 4 Times	Switching failure
 2 sec ----- 5 Times	Overload lower limit cut
 2 sec ----- 6 Times	OH thermistor temp. rise
 2 sec ----- 7 Times	Outdoor thermistor abnormal
 2 sec ----- 8 Times	Acceleration defective
 2 sec ----- 9 Times	Communications error
 2 sec ----- 12 Times	Fan lock error
※1  2 sec ----- 13 Times	Defective EEPROM of outdoor unit
 2 sec ----- 14 Times	Defective active converter
※1  2 sec ----- 15 Times	Discharge error

<Cautions>

- (1) If the interface circuit is faulty when power is supplied, self-diagnosis display will not be displayed.
- (2) When the indoor unit is in the above self-diagnosis modes, the self-diagnosis indicator on the outdoor unit will blink nine time (except for mode marked ※1 or when connected to the branch unit).
- (3) If the indoor unit does not operate at all, check to see if the connecting cord is reversely connected or disconnected.
- (4) To check operation again when the timer or filter lamp is blinking, you can use the remote control for operation (except for mode mark ※2).

SELF-DIAGNOSIS LIGHTING MODE

MODEL: RAC-25NH4, RAC-50NH4

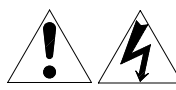

DANGER (DC360V)

- SWITCH OFF MAIN POWER SUPPLY TO THE OUTDOOR UNIT AT LEAST 10 MINUTES BEFORE START THE SERVICING WORK.
- MAKE SURE THE DC VOLTAGE LEVEL AT MEASURING POSITION (P1) AND (N1) IS LESS THAN 10V.
- DO NOT TOUCH THE SCREWS OF THE SYSTEM POWER MODULE WHEN THE UNIT IS TURNED ON. HIGH VOLTAGE STILL REMAIN EVEN AFTER THE UNIT IS TURNED OFF.
- DO NOT TOUCH ANY OTHER PARTS EXCEPT THE SERVICE SWITCH WHEN SERVICE OPERATION IS CONDUCTED.

SELF-DIAGNOSIS LIGHTING MODE ■ LIT ■ BLINKING □ OFF

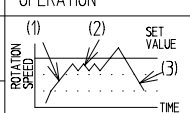
LD301	LD302	SELF-DIAGNOSIS NAME	DETAILS	MAIN CHECK POINT
□	□	[1] DURING OPERATION	COMPRESSOR OPERATION	LD303 LIGHTS, ■
■	□	OVERLOAD (1)	 <p>THIS SHOWS AN OVERLOAD, NOT MALFUNCTION.</p>	
□	■	OVERLOAD (2)	UNDER OVERLOAD CONDITION, THE ROTATION SPEED IS CONTROLLED AUTOMATICALLY IN ORDER TO PROTECT THE COMPRESSOR.	
■	■	OVERLOAD (3)		

OVLDT	NOMLDT	[2] DURING STOP	LD303 GOES OFF. □
□	□	NORMAL STOP	INDOOR THERMOSTAT OFF. MAIN OPERATION OFF. NOT MALFUNCTION.
□	□	1 TIME RESET STOP	WHEN STOPPED WITH POWER RESET. (NORMAL WHEN POWER HAS BEEN TURNED ON.)
□	□	2 TIMES PEAK CURRENT CUT	OVER CURRENT IS DETECTED.
□	□	3 TIMES ABNORMAL LOW SPEED ROTATION	POSITION DETECTION SIGNAL IS NOT INPUT DURING OPERATION.
□	□	4 TIMES SWITCHING FAILURE	FAIL TO SWITCH FROM INITIAL LOW FREQUENCY SYNC. TO POSITION DETECTION SYNC. .
□	□	5 TIMES OVERLOAD LOWER LIMIT CUT	OVERLOAD CONDITION STILL PERSISTING EVEN WHEN ROTATION SPEED IS BELOW THE LOWER RPM LIMIT.
□	□	6 TIMES OH THERMISTOR	OH THERMISTOR IS OPERATING.
□	□	7 TIMES TEMP. RISE	TEMP. RISE
□	□	8 TIMES ABNORMAL THERMISTOR	THERMISTOR IS OPENED OR SHORTED.
□	□	9 TIMES ACCELERATION DEFECTIVE	NO ACCELERATION ABOVE THE LOWER LIMIT OF THE ROTATION SPEED.
□	□	10 TIMES COMMUNICATION ERROR	COMMUNICATION BETWEEN INDOOR UNIT AND OUTDOOR UNIT ARE INTERRUPTED.
□	□	11 TIMES POWER SUPPLY VOLTAGE ERROR	POWER SUPPLY VOLTAGE IS INCORRECT.
□	□	12 TIMES FAN LOCK ERROR	OUTDOOR FAN RPM IS NOT ROTATE AS INTENDED RPM.
□	□	13 TIMES EEPROM READING ERROR	MICROCOMPUTER CANNOT READ THE DATA IN EEPROM.
□	□	14 TIMES ACTIVE CONVERTER DEFECTIVE	OVER VOLTAGE IS DETECTED BY SYSTEM POWER MODULE.

* EXAMPLE OF BLINKING (5 TIMES) ■■■■■ 2SEC (■■■■■ •• LIGHTS FOR 0.25 SEC. AT INTERVAL OF 0.25 SEC.)

WIRING DIAGRAM

BLK : BLACK GRY : GRAY
 BLU : BLUE RED : RED
 BRN : BROWN WHT : WHITE
 GRN : GREEN YEL : YELLOW

SERVICE OPERATION

COLLECT REFRIGERANT FROM INDOOR UNIT AND STORE AT OUTDOOR UNIT.

1. SWITCH OFF THE MAIN POWER SUPPLY AND THEN SWITCH IT ON AGAIN. WAIT FOR 1 MINUTE.
2. PRESS AND HOLD THE SERVICE SWITCH FOR 1 SECOND TO START OUTDOOR UNIT IN COOLING OPERATION. IN ORDER TO PREVENT PARTS FROM DAMAGE, DO NOT OPERATE THE OUTDOOR UNIT FOR MORE THAN 5 MINUTES.
3. PRESS AND HOLD THE SERVICE SWITCH FOR 1 SECOND TO STOP THE SERVICE OPERATION.
4. REPEAT STEP 1 TO 3 IF SERVICE OPERATION NEED TO BE REPEATED.

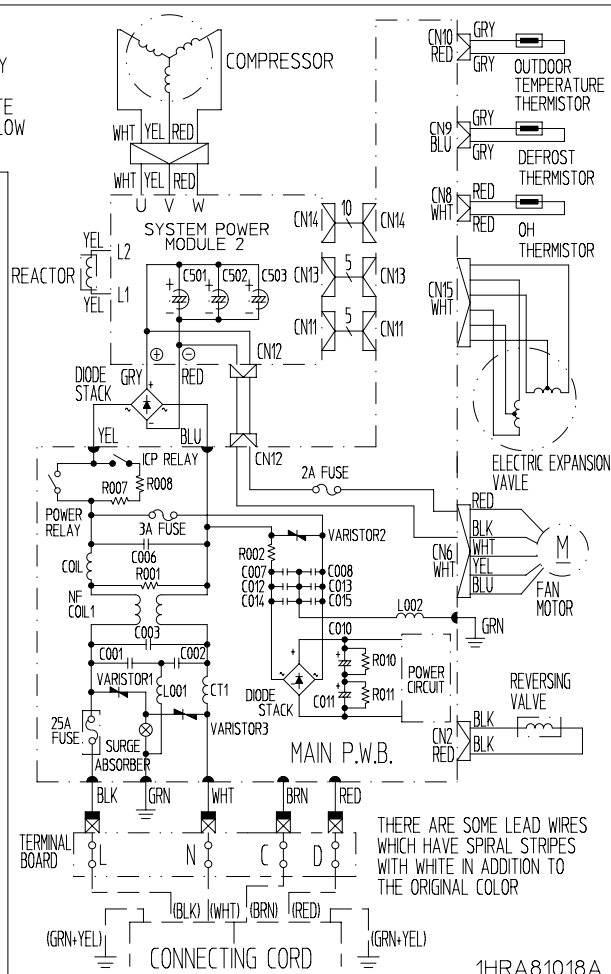
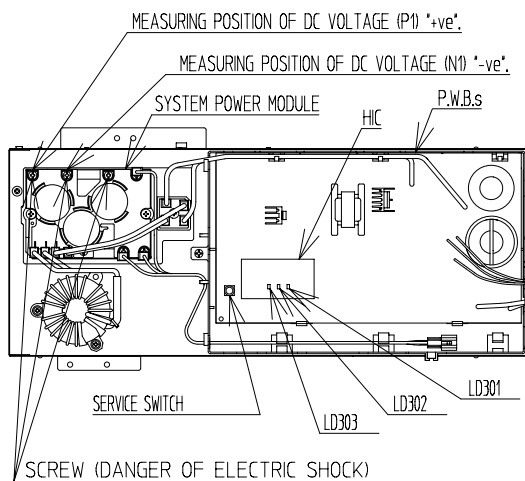

CHECKING INDOOR UNIT ELECTRICAL PARTS

1. Power does not come on (no operation)

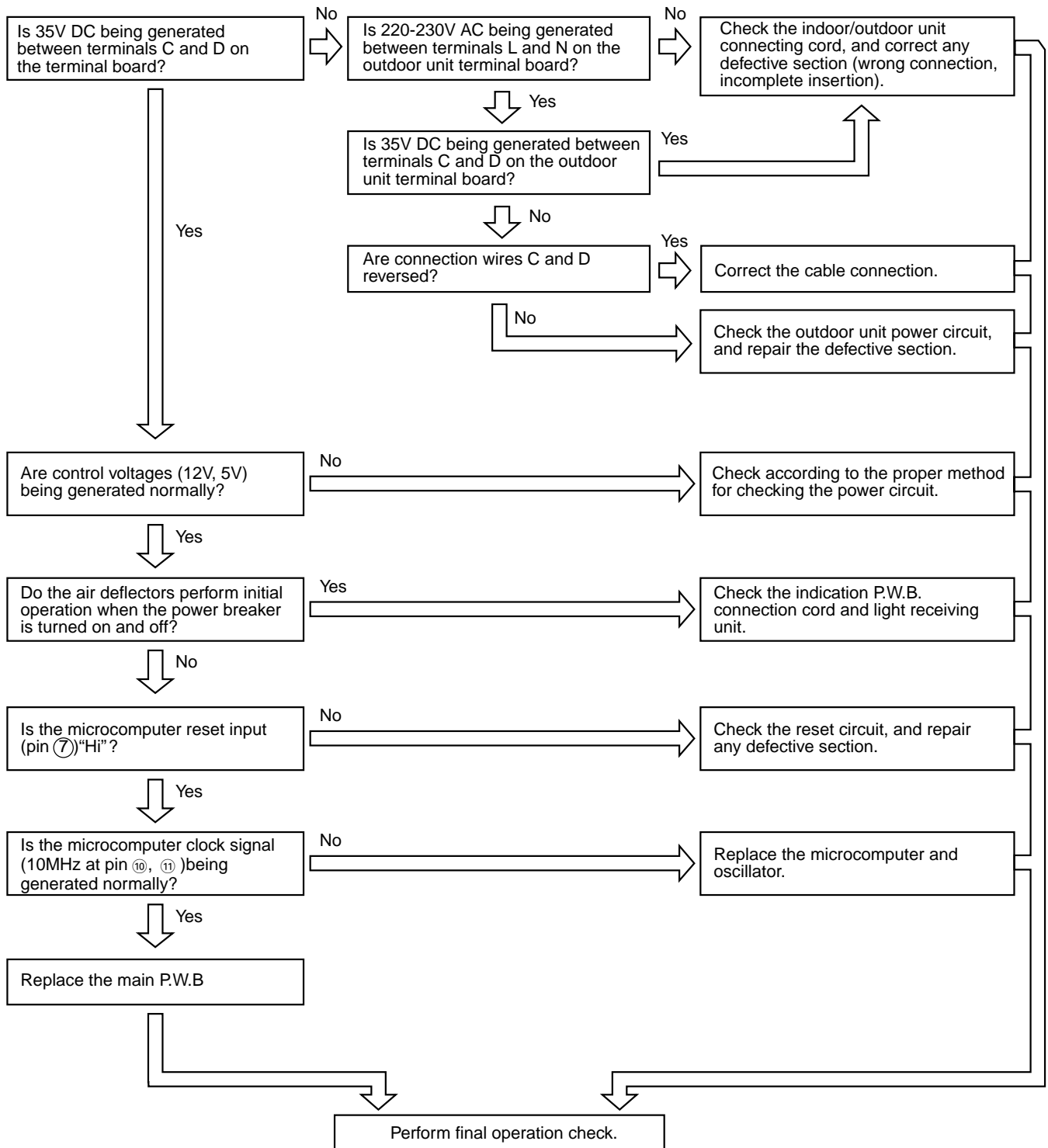

2. Outdoor unit does not operate (but receives remote infrared signal)

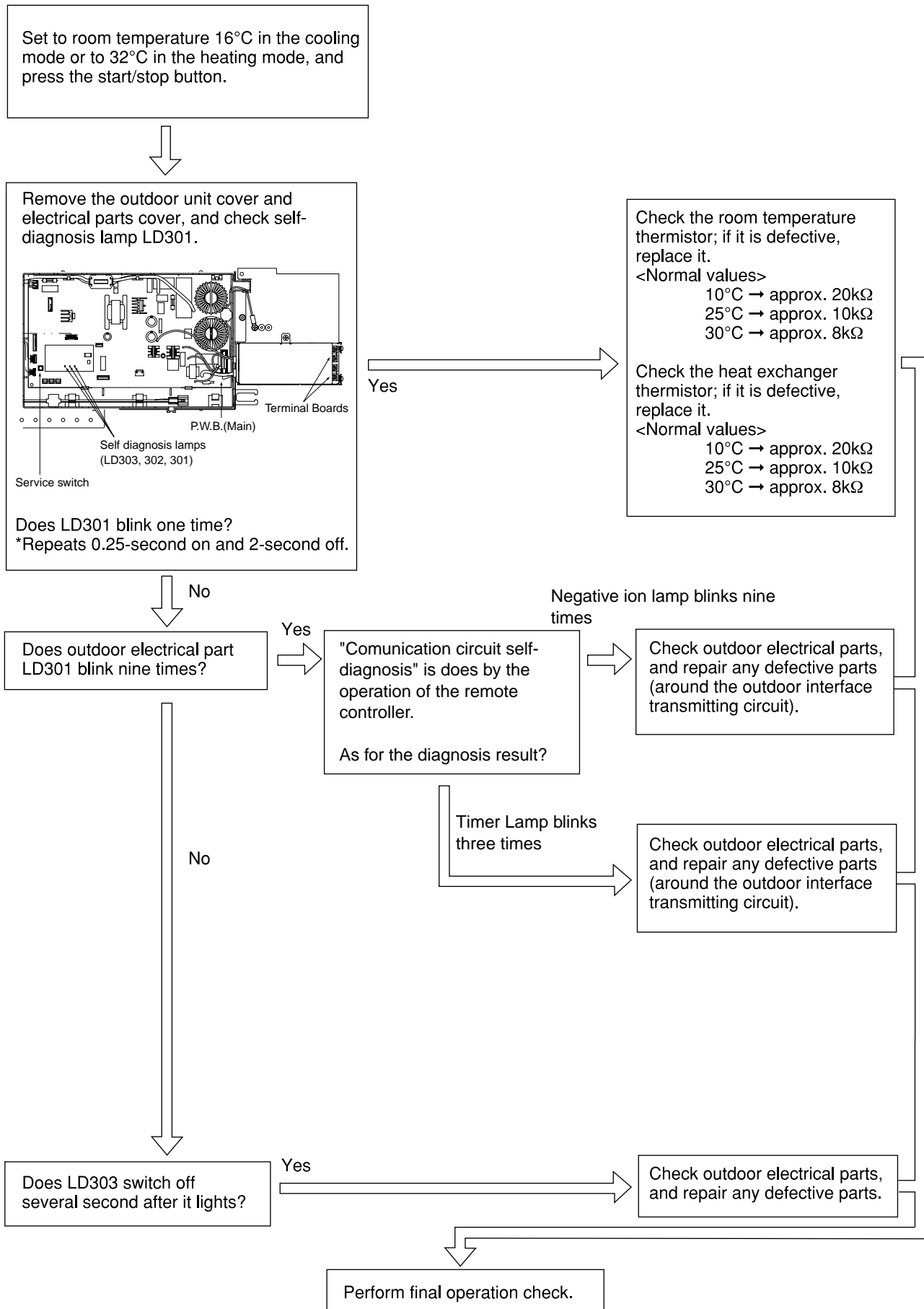

3. Indoor fan speed does not change (others are normal)

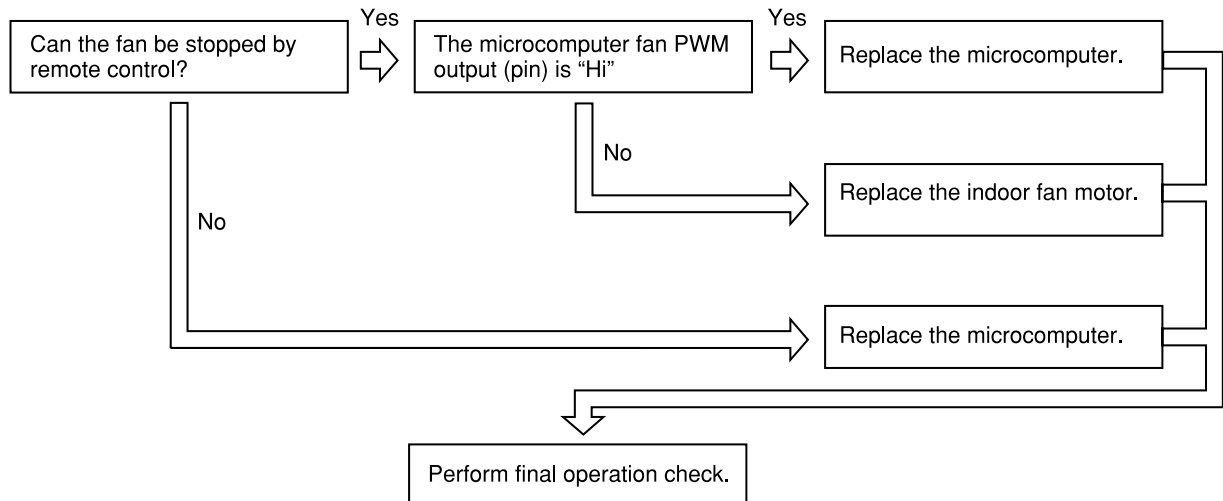

4. Air deflector does not move (others are normal)

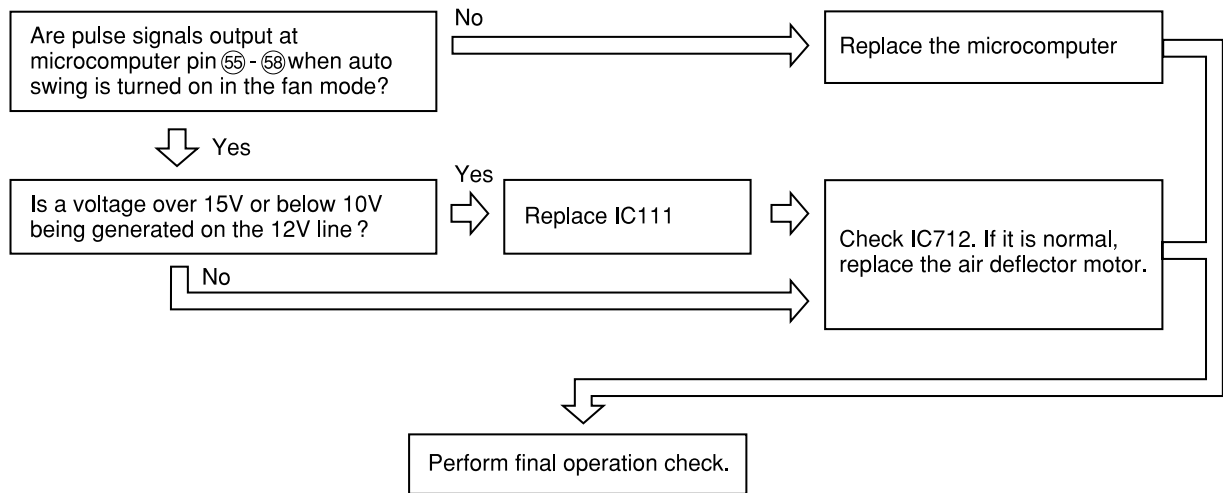

5. All systems stop from several seconds minutes to several after operation is started (all indicators are also off)

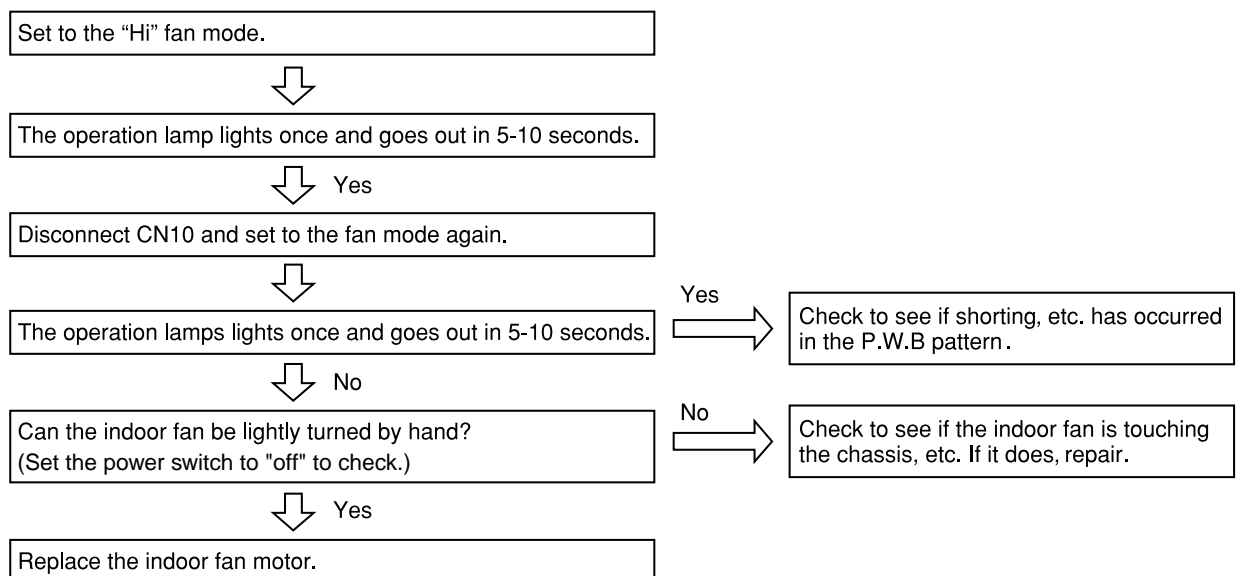

6. Check the main P.W.B (power circuit)

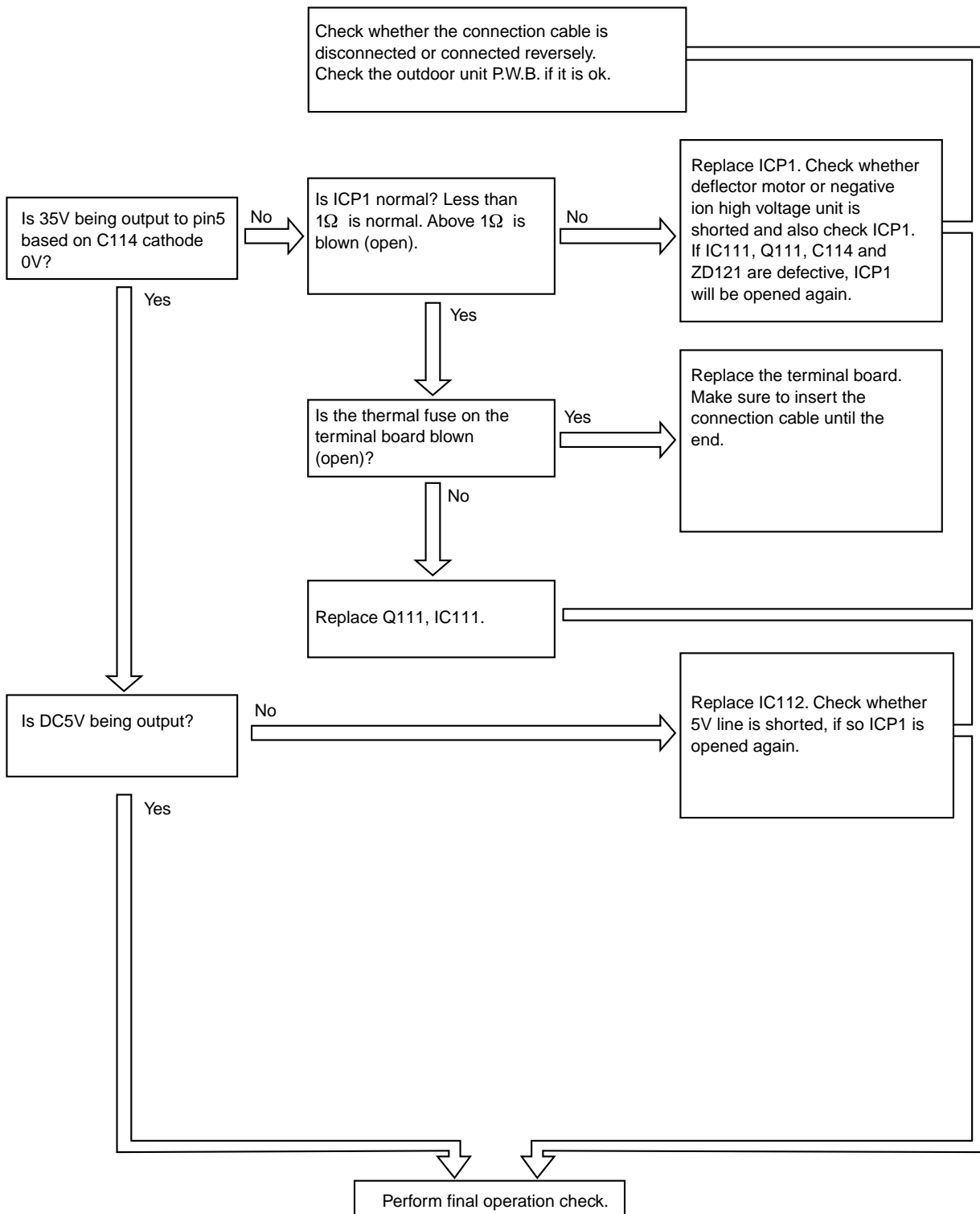

※1 During the operation is being stopped, 12V line may change to 7V.

CHECKING THE REMOTE CONTROLLER

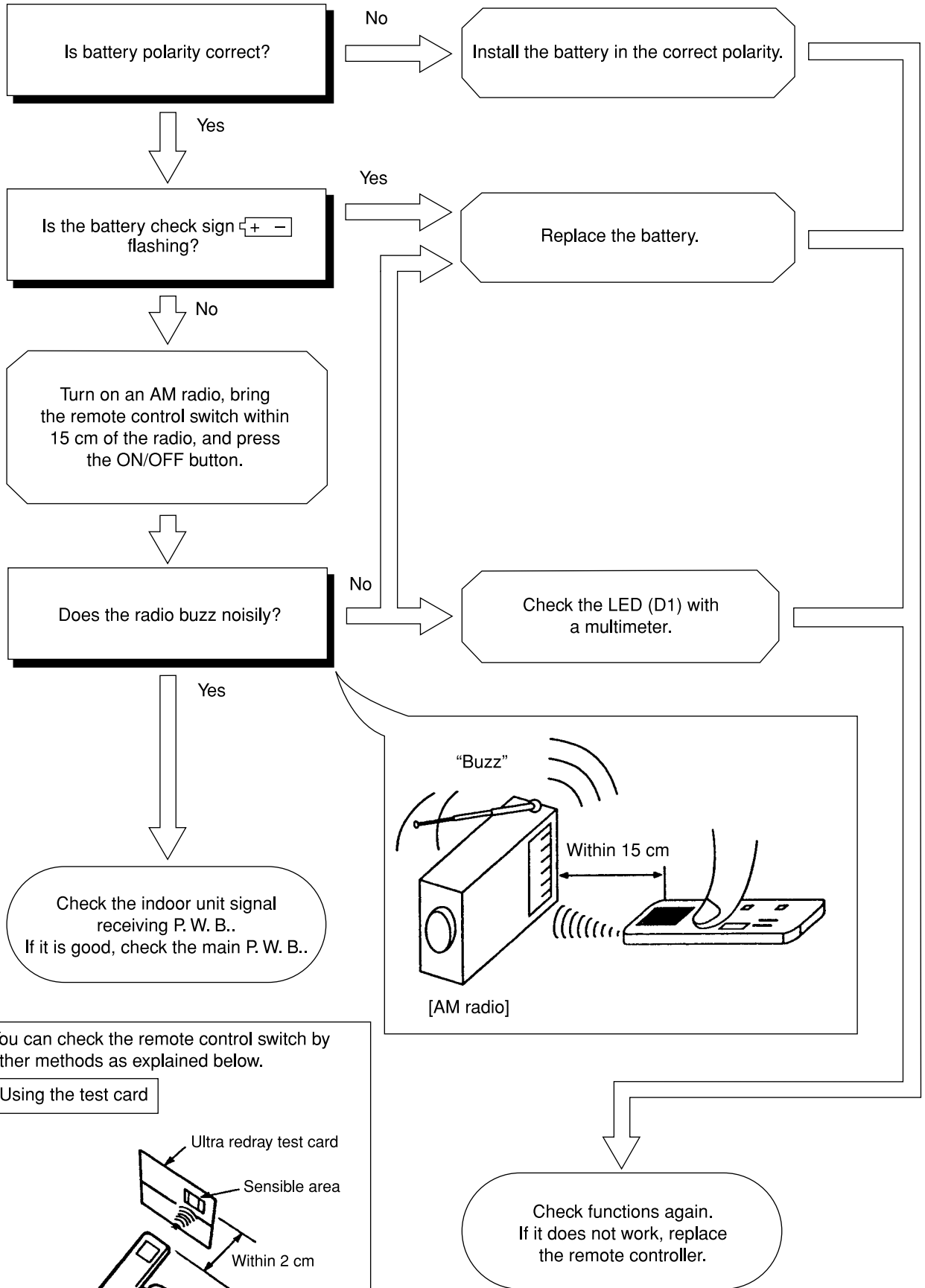

You can check the remote control switch by other methods as explained below.

Using the test card

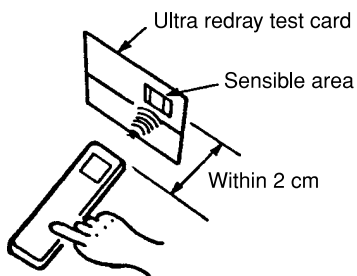

The sensible area should flash in orange when you operate the remote control unit if it is good.

CHECKING THE OUTDOOR UNIT ELECTRICAL PARTS

MODEL RAC-25NH4, RAC-50NH4

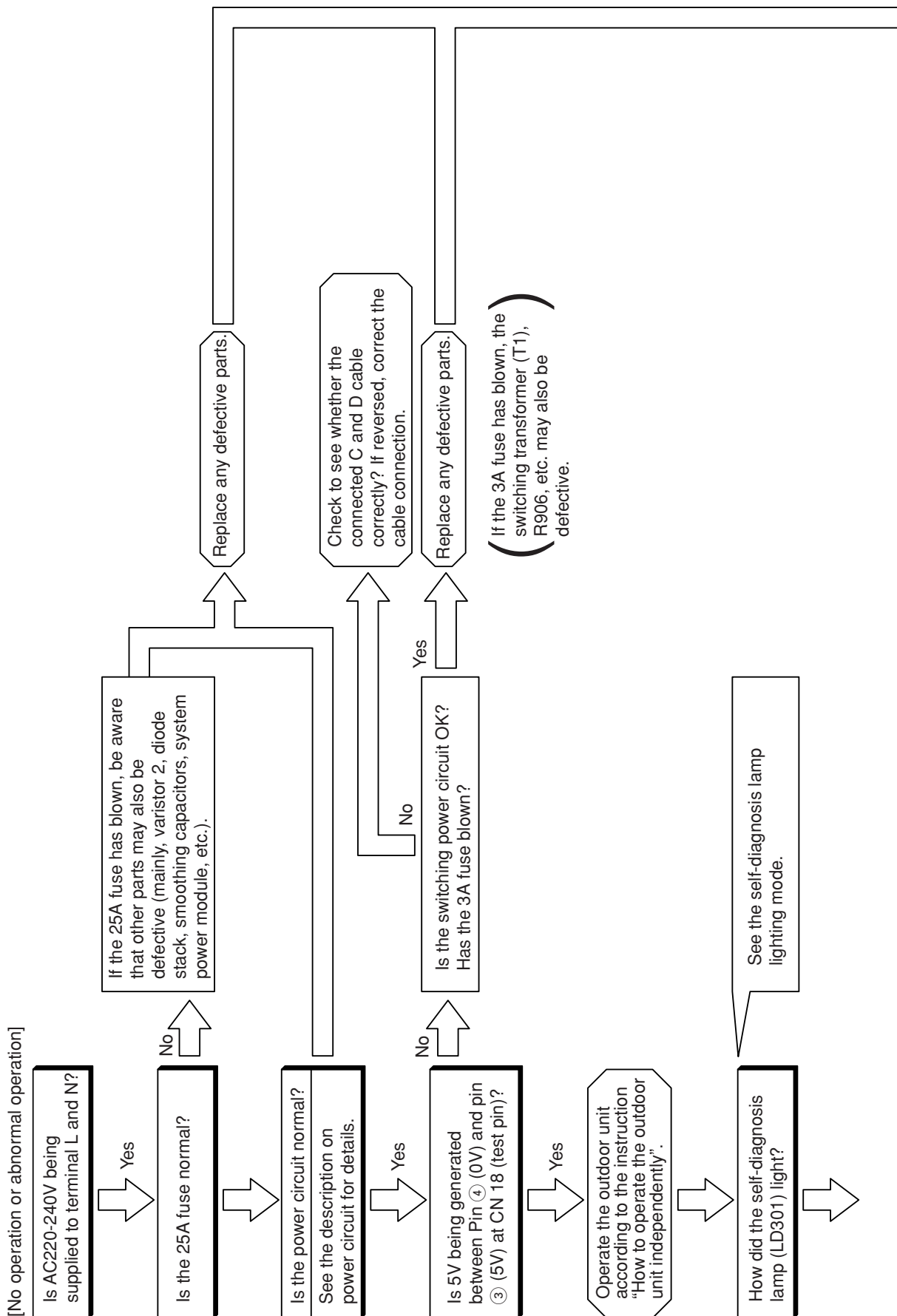

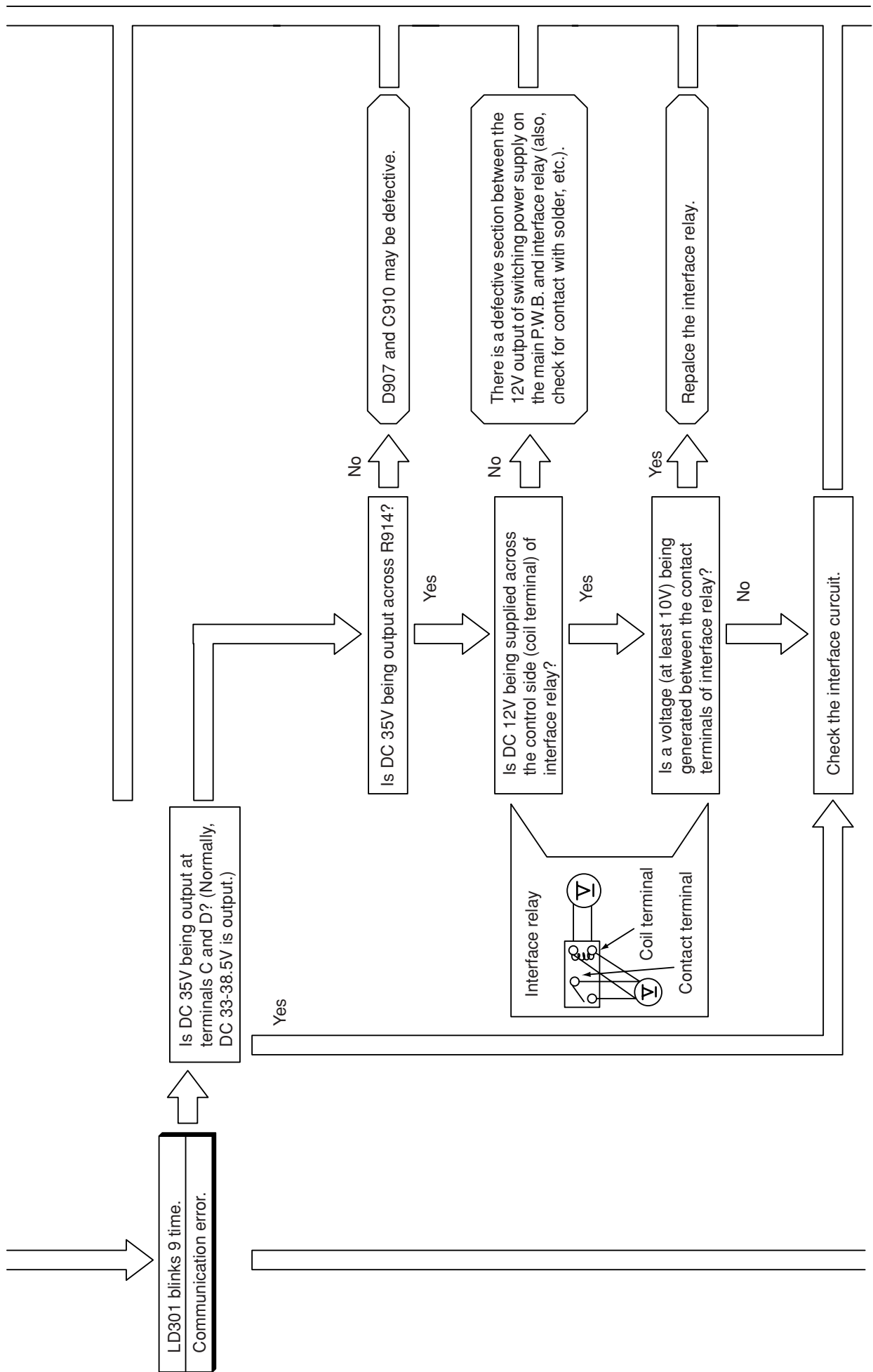

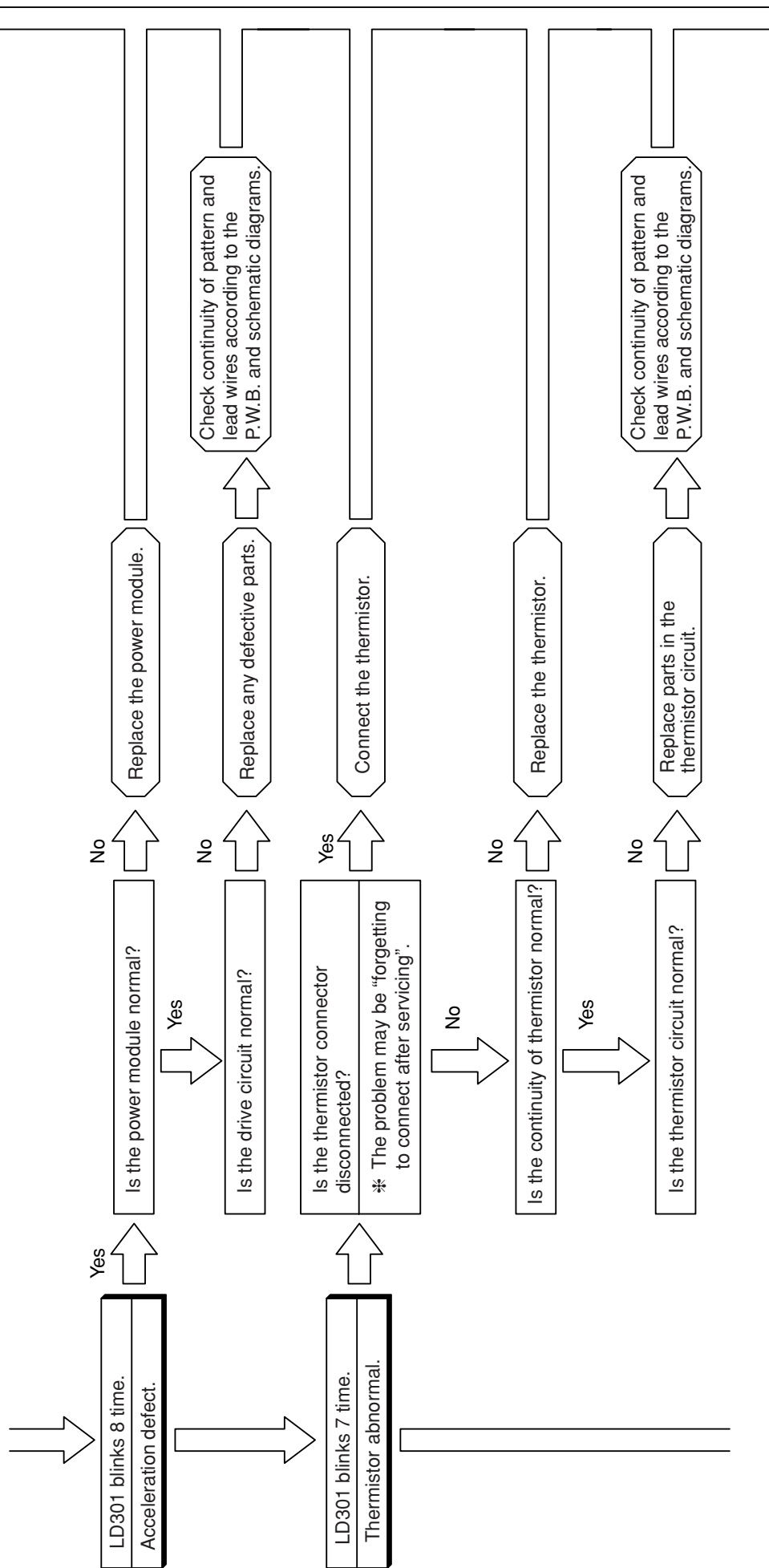

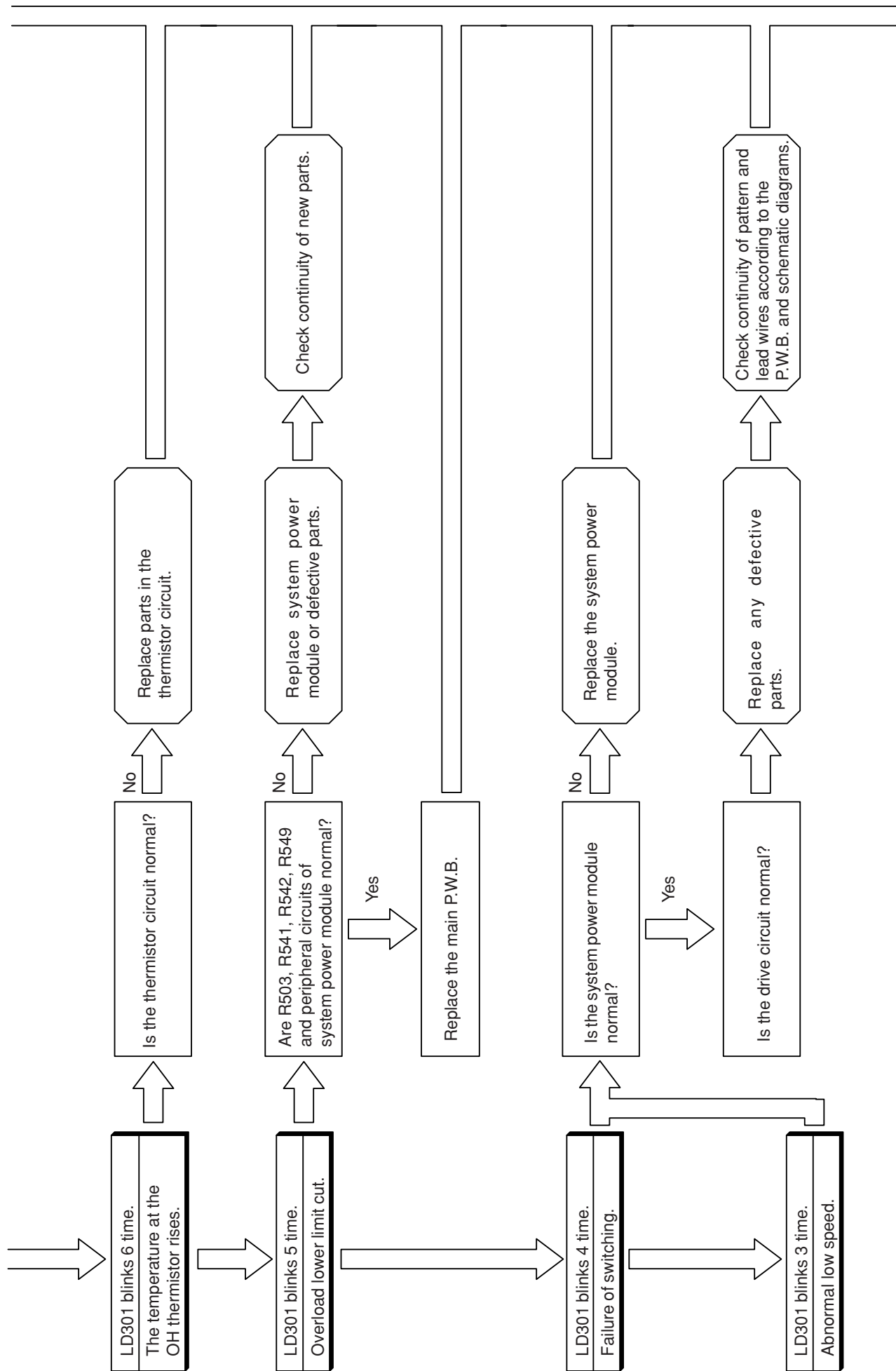

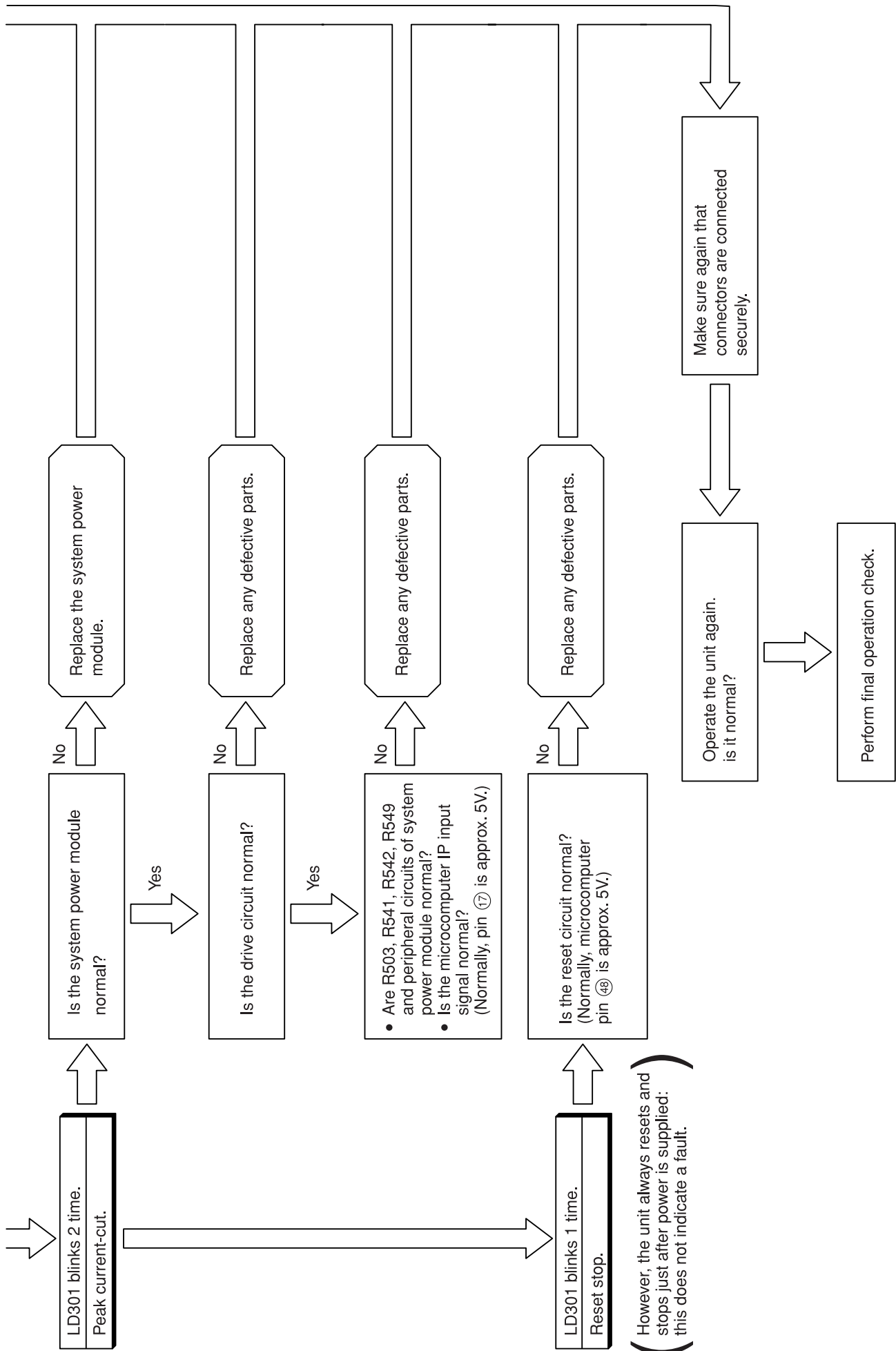

POWER CIRCUIT

Phenomenon 1 <Rotation speed does not increase>

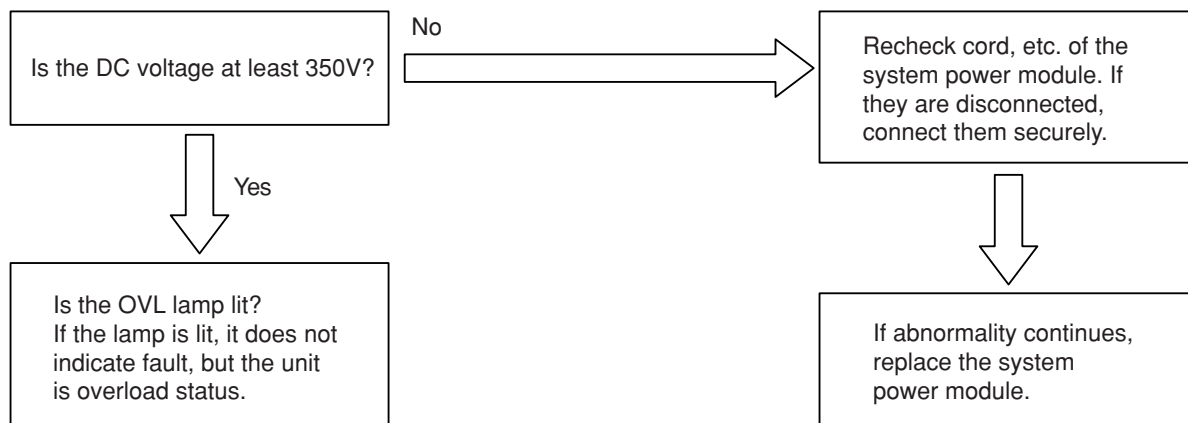

Overvoltage defect: system power module faulty (15-times blinking)

CHECKING THE REFRIGERATING CYCLE

(JUDGING BETWEEN GAS LEAKAGE AND COMPRESSOR DEFECTIVE)

1. Troubleshooting procedure (No operation, No heating, No cooling)

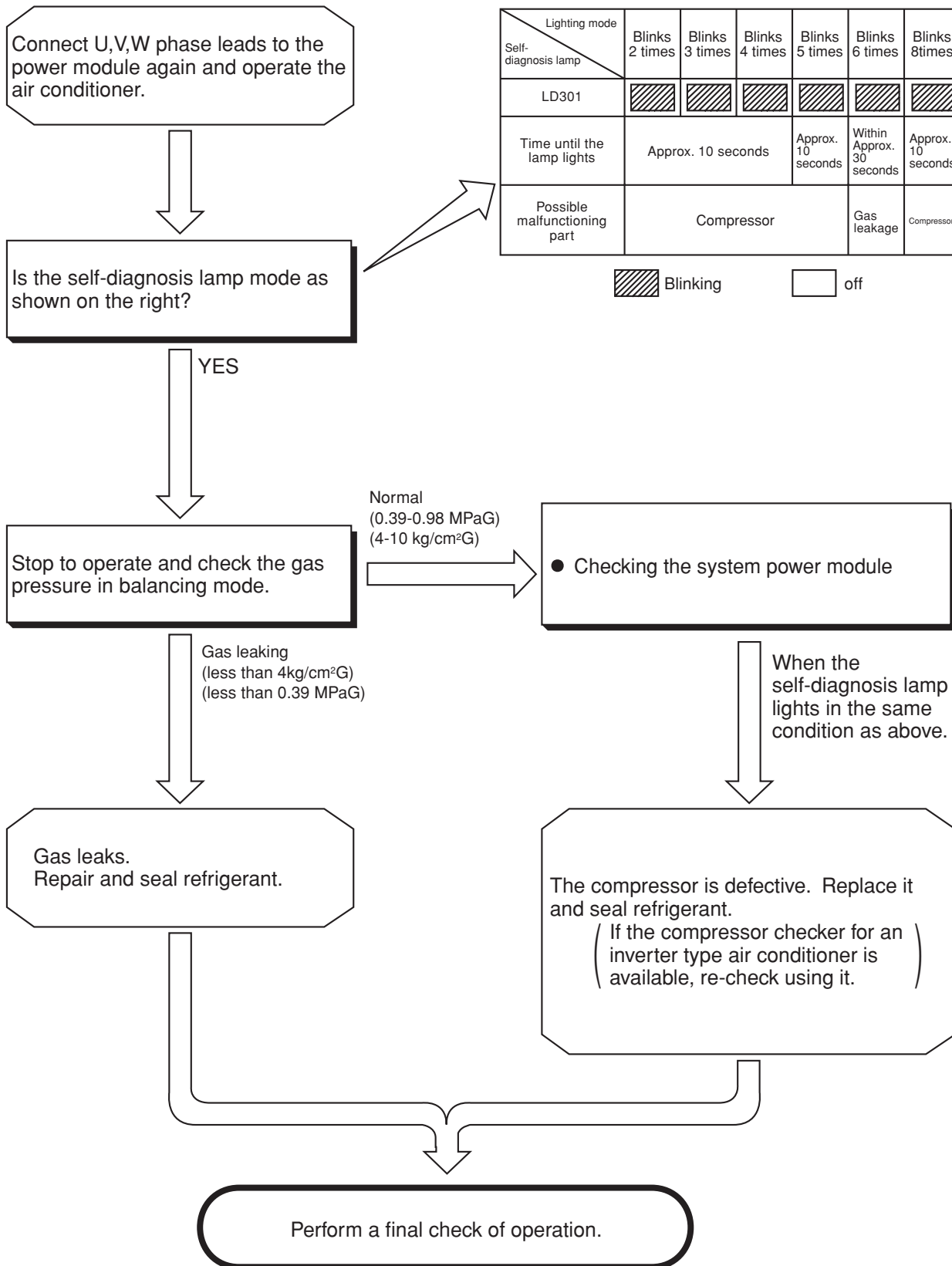

HOW TO CHECK SYSTEM POWER MODULE

Checking system power module using tester

Set tester to resistance range (X 100)

If indicator does not swing in the following conductivity check, the system power module is normal.

(In case of digital tester, since built-in battery is set in reverse direction, ⊕ and ⊖ terminals are reversed.)

⚠ CAUTION

If inner circuit of system power module is disconnected (open), the indicator of tester will not swing and this may assumed as normal. In this case, if indicator swings when ⊕ and ⊖ terminals are connected in reverse of diagram below, it is normal. Furthermore, compare how indicator swings at U, V and W phases. If indicator swings the same way at each point, it is normal.

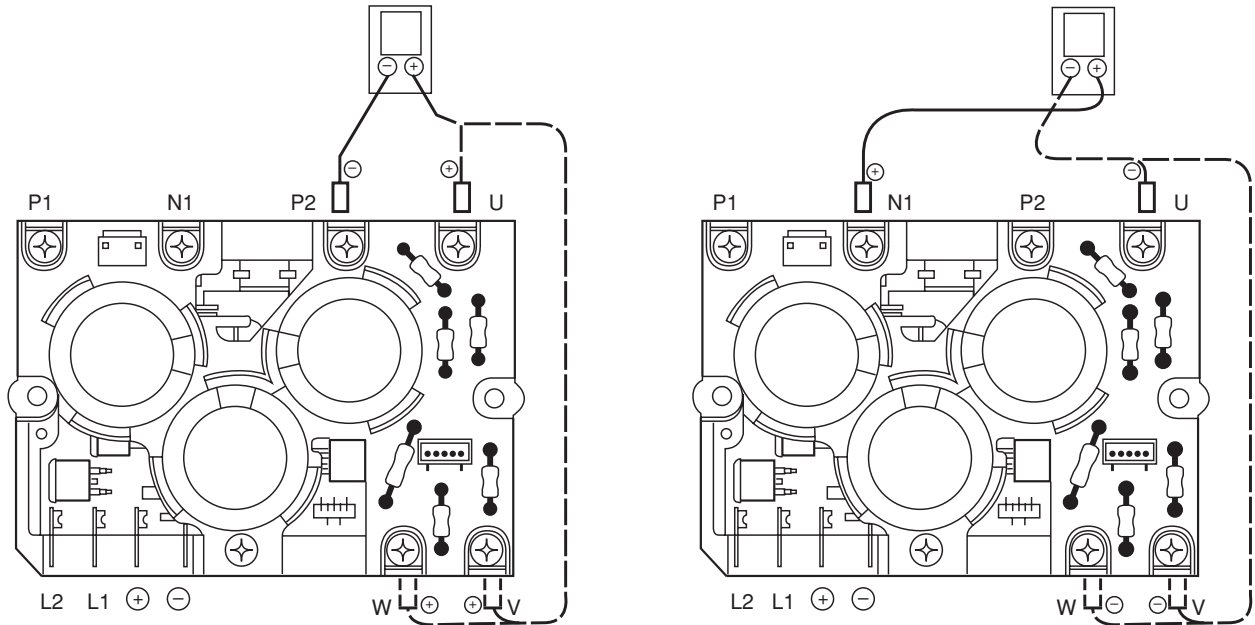

HOW TO OPERATE USING THE SERVICE SWITCH THE OUTDOOR UNIT

MODEL RAC-25NH4, RAC-50NH4

1. Turn off the power supply to outdoor unit and then turn on again.
2. Remove the electrical box cover.

LD303 (red) will light and the unit will operate in the forced cooling mode at this time.

Never operate the unit for more than 5 minutes.

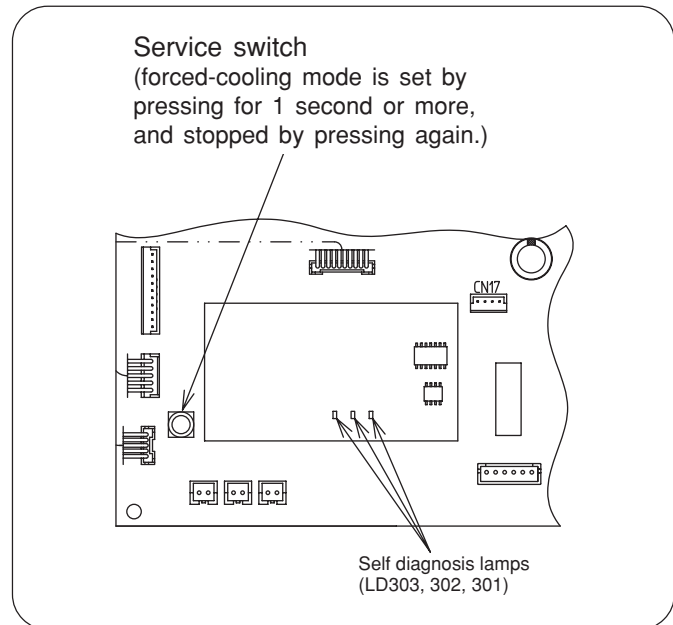
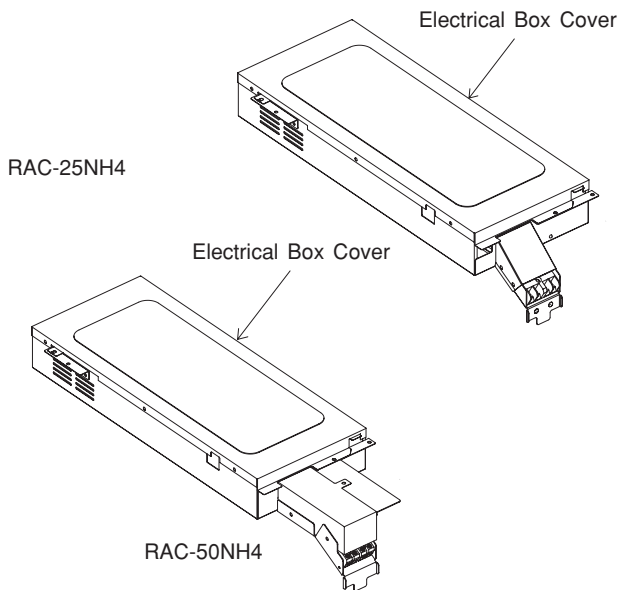

(Cautions)

- (1) If interface signal (DC 35V) terminals C and D are not connected when the outdoor unit is in forced cool mode, the outdoor unit defect indicator (LD301) will blink 9 times during operation to indicate communication error.
- (2) If checking is done with the compressor connector disconnected, the unit will continue normal operation when the electrical parts are normal, or it will repeat operating for approx. one minute and stop due to overload power limit cut, or it will operate in the overload status.

Be sure to push the service switch again to stop the forced cool operation.

HOW TO OPERATE THE OUTDOOR UNIT INDEPENDENTLY

1. Connect the large dia. pipe side and small dia. pipe side service valves using a pipe.

Connect the small diameter service valve and the large diameter service valve using the reducing union and copper pipe as shown on the right.

Charge refrigerant of 300g after vacuuming (※ 1)

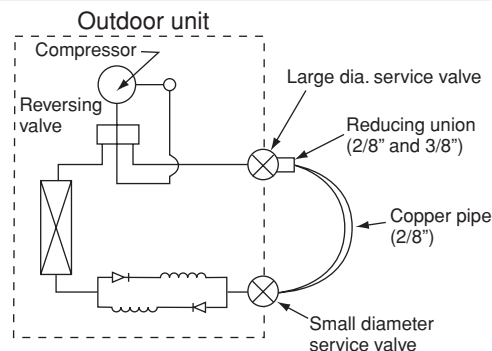

Parts to be prepared

- (1) Reducing union
2/8" (6.35mm)
1/2" (12.7mm)
- (2) Copper pipe (2/8" and 1/2")
- (3) Shorting leads
2 leads approx. 10 cm long with alligator clip or IC clip

Do not operate for more than 5 minutes

The operation method is the same as "How to operate using the connector to servicing the outdoor unit".

※ 1 The charging amount of 300g is equivalent to the load in normal operation.

SYSTEM POWER MODULE DIAGNOSIS

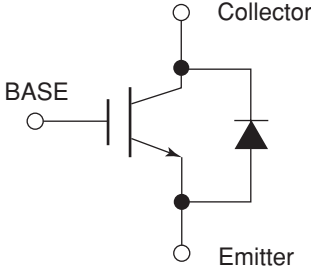
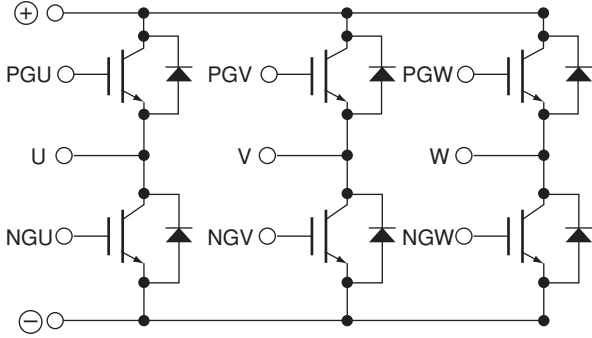
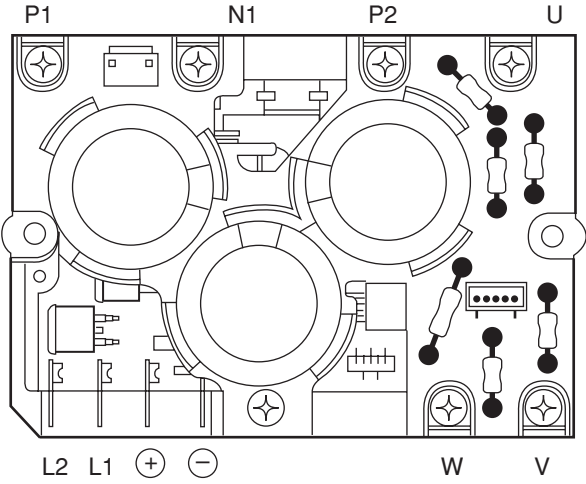
<p>Circuit diagram of the device (excepting the reflux diode)</p>	
<p>Circuit diagram of the module</p>	
<p>Terminals symbol mark of the module</p> <p>※ See next page for measuring value using tester</p>	

PARTS LIST AND DIAGRAM

INDOOR UNIT

MODEL : RAF-25NH4, RAF-50NH4

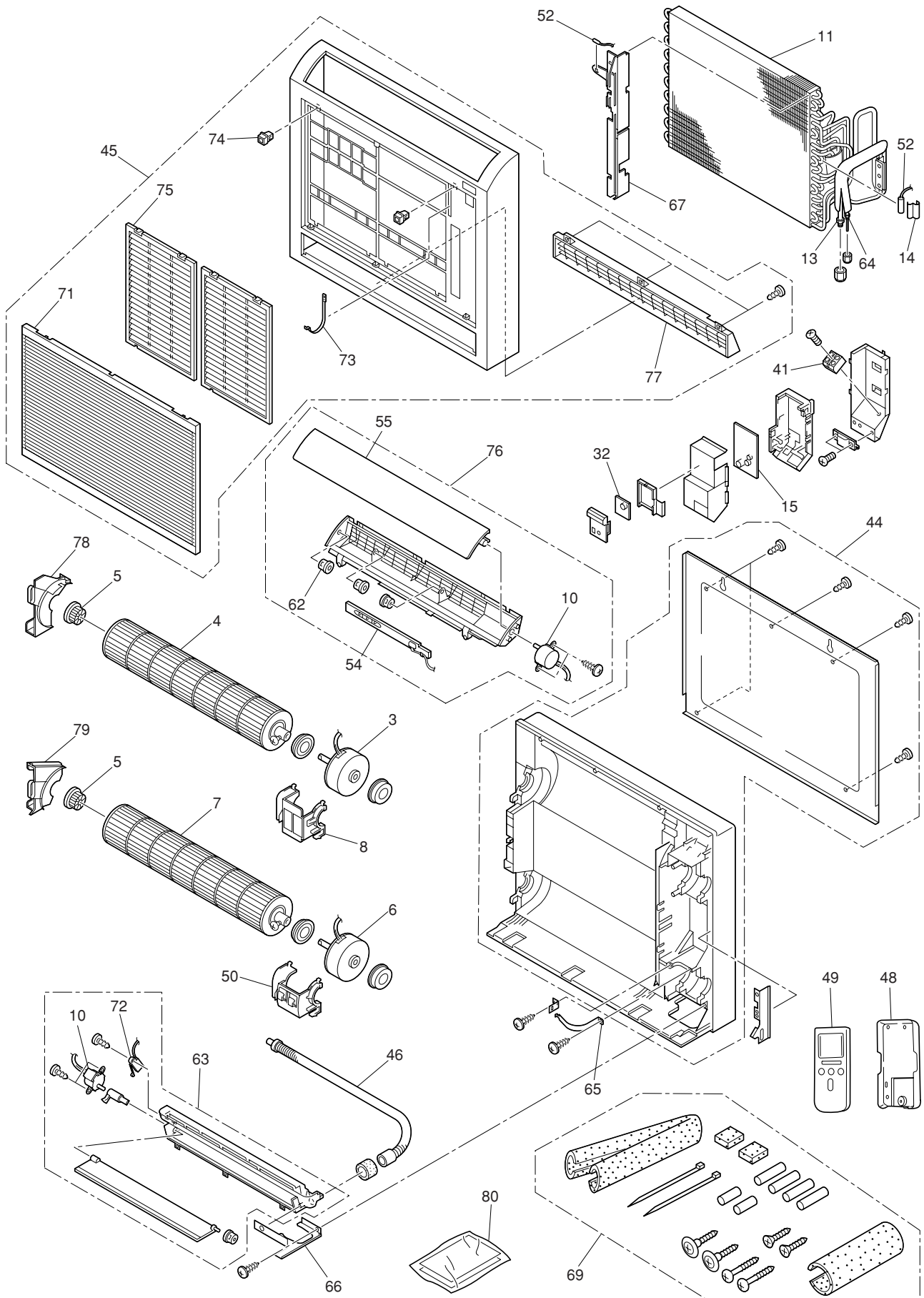

MODEL RAF-25NH4

NO.	PART NO. RAF-25NH4	Q'TY / UNIT	PARTS NAME
3	ATI-0972B 902	1	FAN MOTOR (UPPER)
4	ATI-0972B 903	1	TANGENTIAL FAN (UPPER)
5	RAS4010LX2 010	2	FAN SUPPORT ASSEMBLY
6	ATI-0972B 905	1	FAN MOTOR (LOWER)
7	ATI-0972B 906	1	TANGENTIAL FAN (LOWER)
8	ATI-0972B 904	1	FAN MOTOR SUPPORT (UPPER)
10	RAS-2810NX 045	2	AUTO SWEEP MOTOR
11	RAF-25NH4 902	1	HEAT EXCHANGER ASSEMBLY
13	RAS-287AX 802	1	UNION (3)
14	ATI-0972B 935	1	BULB SUPPORT
15	RAF-25NH4 903	1	P.W.B. (MAIN)
32	ATI-0972B 914	1	P.W.B. (SWITCH)
41	ATI-0972B 936	1	TERMINAL BORD (2P)
44	RAF-25NH4 901	1	CABINET
45	RAF-25NH4 906	1	FRONT COVER ASSEMBLY
46	KFR47GBPM 907	1	DRAIN HOSE
48	RAS-258JX 004	1	REMOTE CONTROL SUPPORT
49	RAD-25QH4 905	1	REMOTE CONTROL ASSEMBLY
50	ATI-0972B 912	1	FAN MOTOR SUPPORT (LOWER)
52	ATI-0972B 915	1	THERMISTOR
54	RAF-25NH4 905	1	P.W.B. (INDICATION)
55	RAF-25NH4 909	1	WIDE DEFLECTOR
62	RAS-3610LX 003	3	DEFLECTOR SUPPORT
63	ATI-0972B 917	1	DISCHARGE FRAME
64	RAS-2810KX 009	1	UNION (2)
65	ATI-0972B 925	1	PIPE BAND
66	ATI-0972B 926	1	RAT PREVENTION COVER
67	ATI-0972B 927	1	PIPE COVER

MODEL RAF-25NH4

NO.	PART NO. RAF-25NH4	Q'TY / UNIT	PARTS NAME
69	ATI-0972B 929	1	ACCESSORIES ASSEMBLY
71	RAF-25NH4 907	1	FRONT PANEL
72	ATI-0972B 932	1	DAMPER LIMIT SWITCH
73	ATI-0972B 933	1	BAND (FOR FRONT PANEL)
74	RAP-5CPJ 004	2	LATCH 1 (FRONT COVER)
75	ATI-0972B 934	2	AIR FILTER
76	RAF-25NH4 904	1	TOP FRAME
77	RAF-25NH4 908	1	DISCHARGE GRILL
78	ATI-0972B 922	1	FAN COVER (UPPER)
79	ATI-0972B 923	1	FAN COVER (LOWER)

MODEL RAF-50NH4

NO.	PART NO. RAF-50NH4	Q'TY / UNIT	PARTS NAME
3	ATI-0972B 902	1	FAN MOTOR (UPPER)
4	ATI-0972B 903	1	TANGENTIAL FAN (UPPER)
5	RAS4010LX2 010	2	FAN SUPPORT ASSEMBLY
6	ATI-0972B 905	1	FAN MOTOR (LOWER)
7	ATI-0972B 906	1	TANGENTIAL FAN (LOWER)
8	ATI-0972B 904	1	FAN MOTOR SUPPORT (UPPER)
10	RAS-2810NX 045	2	AUTO SWEEP MOTOR
11	ATI-0972B 907	1	HEAT EXCHANGER ASSEMBLY
13	RAS4010KX2 008	1	UNION (4)
14	ATI-0972B 935	1	BULB SUPPORT
15	RAF-50NH4 901	1	P.W.B. (MAIN)
32	ATI-0972B 914	1	P.W.B. (SWITCH)
41	ATI-0972B 936	1	TERMINAL BORD (2P)
44	RAF-25NH4 901	1	CABINET
45	RAF-25NH4 906	1	FRONT COVER ASSEMBLY
46	KFR47GBPM 907	1	DRAIN HOSE
48	RAS-258JX 004	1	REMOTE CONTROL SUPPORT
49	RAD-25QH4 905	1	REMOTE CONTROL ASSEMBLY
50	ATI-0972B 912	1	FAN MOTOR SUPPORT (LOWER)
52	ATI-0972B 915	1	THERMISTOR
54	RAF-25NH4 905	1	P.W.B. (INDICATION)
55	RAF-25NH4 909	1	WIDE DEFLECTOR
62	RAS-3610LX 003	3	DEFLECTOR SUPPORT
63	ATI-0972B 917	1	DISCHARGE FRAME
64	RAS-2810KX 009	1	UNION (2)
65	ATI-0972B 925	1	PIPE BAND
66	ATI-0972B 926	1	RAT PREVENTION COVER
67	ATI-0972B 927	1	PIPE COVER

MODEL RAF-50NH4

NO.	PART NO. RAF-50NH4	Q'TY / UNIT	PARTS NAME
69	ATI-0972B 929	1	ACCESSORIES ASSEMBLY
71	RAF-25NH4 907	1	FRONT PANEL
72	ATI-0972B 932	1	DAMPER LIMIT SWITCH
73	ATI-0972B 933	1	BAND (FOR FRONT PANEL)
74	RAP-5CPJ 004	2	LATCH 1 (FRONT COVER)
75	ATI-0972B 934	2	AIR FILTER
76	RAF-25NH4 904	1	TOP FRAME
77	RAF-25NH4 908	1	DISCHARGE GRILL
78	ATI-0972B 922	1	FAN COVER (UPPER)
79	ATI-0972B 923	1	FAN COVER (LOWER)

OUTDOOR UNIT MODEL : RAC-25NH4

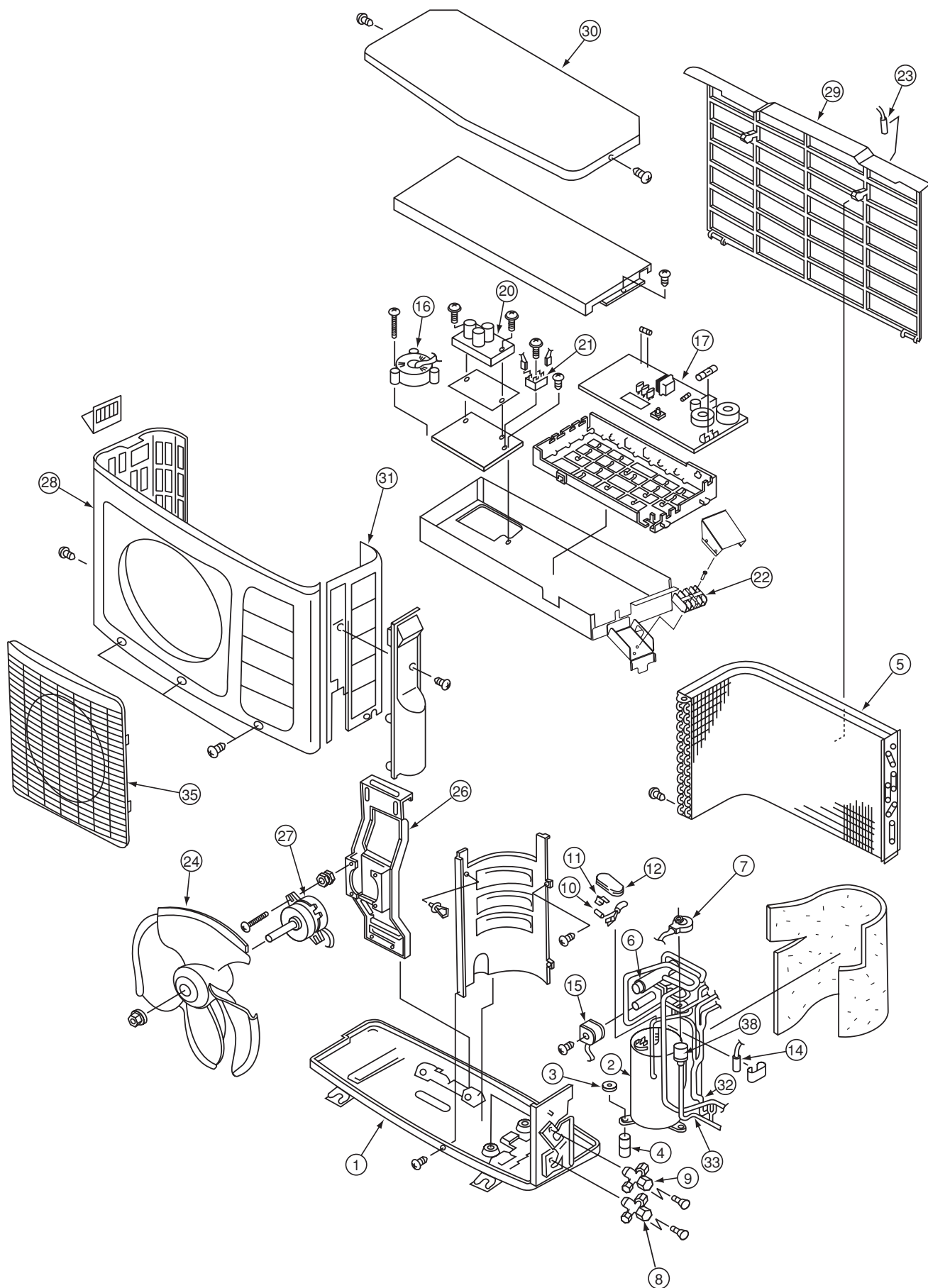

MODEL RAC-25NH4

NO.	PART NO. RAC-25NH4	Q'TY / UNIT	PARTS NAME
1	PMRAC-25NH4 918	1	BASE
2	PMRAC-25NH4 908	1	COMPRESSOR
3	KPNT1 001	6	PUSH NUT
4	RAC-2226HV 805	3	COMPRESSOR RUBBER
5	PMRAC-25NH4 901	1	CONDENSER
6	PMRAC-25NH4 902	1	REVERSING VALVE
7	PMRAC-25NH4 903	1	ELECTRICAL EXPANSION COIL
8	PMRAC-25NH4 904	1	VALVE (2S)
9	PMRAC-25NH4 905	1	VALVE (4S)
10	PMRAC-40CNH2 914	1	THERMISTOR (OH)
11	PMRAC-25NH4 909	1	OVERHEAT THERMISTOR SUPPORT
12	PMRAC-25NH4 910	1	OVERLOAD RELAY COVER
14	PMRAC-40CNH2 915	1	THERMISTOR (DEFROST)
15	PMRAC-07CHV1 921	1	COIL (REVERSING VALVE)
16	PMRAC-40CNH2 908	1	REACTOR
17	PMRAC-25NH4 906	1	P.W.B (MAIN)
20	PMRAC-25NH4 912	1	SYSTEM POWER MODULE
21	PMRAC-40CNH2 902	1	DIODE STACK (D25VB60)
22	PMRAC-25NH4 913	1	TERMINAL BOARD (4P)
23	PMRAC-40CNH2 916	1	THERMISTOR (OUTSIDE TEMPERATURE)
24	PMRAC-25CNH2 902	1	PROPELLER FAN
26	PMRAC-25NH4 914	1	SUPPORT (FAN MOTOR)
27	PMRAC-40CNH2 919	1	FAN MOTOR (40W)
28	PMRAC-51CA1 901	1	CABINET
29	PMRAC-51CA1 908	1	NET
30	PMRAC-51CA1 909	1	TOP COVER
31	PMRAC-25NH4 917	1	SIDE PLATE-R
32	PMRAC-25NH4 915	1	STRAINER
33	PMRAC-25NH4 907	1	STRAINER
35	PMRAC-09CHA1 903	1	GRILL
38	PMRAC-25NH4 916	1	EXPANSION VALVE

PARTS LIST AND DIAGRAM

OUTDOOR UNIT MODEL : RAC-50NH4

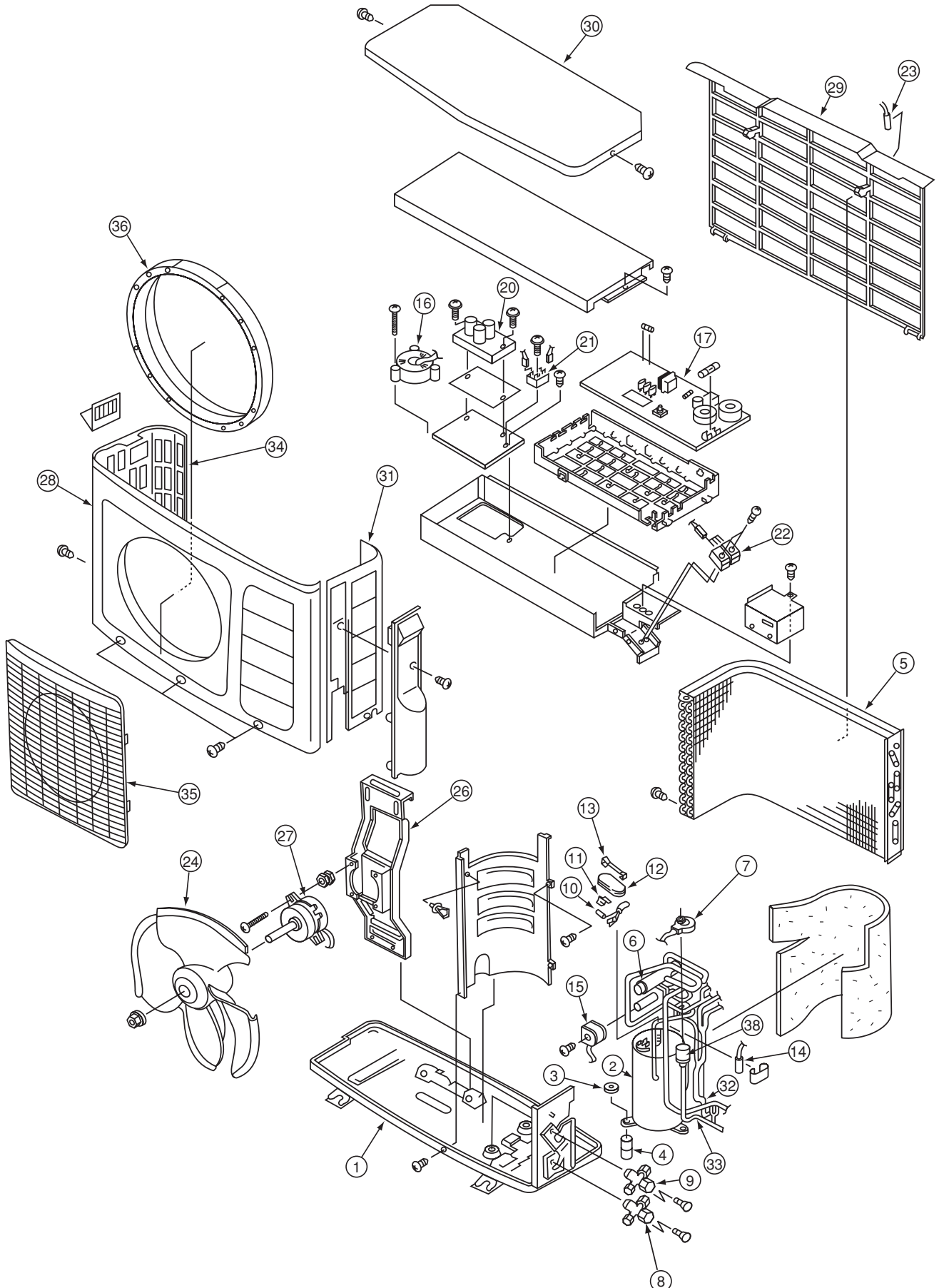

MODEL RAC-50NH4

NO.	PART NO. RAC-50NH4	Q'TY / UNIT	PARTS NAME
1	PMRAC-50NH4 901	1	BASE
2	PMRAC-50NH4 907	1	COMPRESSOR
3	KPNT1 001	4	PUSH NUT
4	RAC-2226HV 805	3	COMPRESSOR RUBBER
5	PMRAC-50NH4 902	1	CONDENSER
6	PMRAC-25NH4 902	1	REVERSING VALVE
7	PMRAC-25NH4 903	1	ELECTRICAL EXPANSION COIL
8	PMRAC-50NH4 903	1	VALVE (2S)
9	PMRAC-50NH4 904	1	VALVE (4S)
10	PMRAC-40CNH2 914	1	THERMISTOR (OH)
11	PMRAC-25NH4 909	1	OVERHEAT THERMISTOR SUPPORT
12	PMRAC-25NH4 910	1	OVERLOAD RELAY COVER
14	PMRAC-40CNH2 915	1	THERMISTOR (DEFROST)
15	PMRAC-07CHV1 921	1	COIL (REVERSING VALVE)
16	PMRAC-40CNH2 908	1	REACTOR
17	PMRAC-50NH4 905	1	P.W.B (MAIN)
20	PMRAC-40CNH2 901	1	SYSTEM POWER MODULE
21	PMRAC-40CNH2 902	1	DIODE STACK (D25VB60)
22	PMRAS-10C6M 002	2	TERMINAL BOARD (2P)
23	PMRAC-40CNH2 916	1	THERMISTOR (OUTSIDE TEMPERATURE)
24	PMRAC-40CNH2 917	1	PROPELLER FAN
26	PMRAC-40CNH2 918	1	SUPPORT (FAN MOTOR)
27	PMRAC-40CNH2 919	1	FAN MOTOR (40W)
28	PMRAC-40CNH2 904	1	CABINET
29	PMRAC-40CNH2 921	1	NET
30	PMRAC-40CNH2 922	1	TOP COVER
31	PMRAC-50NH4 910	1	SIDE PLATE-R
32	PMRAC-50NH4 906	1	STRAINER
33	PMRAC-50NH4 909	1	STRAINER
34	PMRAC-40CNH2 926	1	SIDE PLATE-L
35	PMRAC-40CNH2 928	1	GRILL
36	PMRAC-40CNH2 920	1	MOUTH RING
38	PMRAC-25NH4 916	1	EXPANSION VALVE

HITACHI

RAF-25NH4/RAC-25NH4
RAF-50NH4/RAC-50NH4

PM NO. 0181E

Printed in Malaysia